



EM9980 C *plus* DiagnosticLine

NEW

DiagnosticLine



TECHNOLOGY
PARTNER
product



- Fully Automatic
- Touchscreen
- Laser Point
- Contactless
- iPos** LITE Intelligent Positioning
- LED Light
- WM** WEIGHT MANAGEMENT Integrated Software Suite
- Laser Runout



Versione WINUT - WINUT version

Equilibratrice diagnostica superautomatica che lavora senza mai toccare la ruota



Super-automatic diagnostic wheel balancer that works without ever touching the wheel



EM9980 C *plus*

DiagnosticLine



Completamente automatica
Fully automatic



Interfaccia Touchscreen
Touchscreen interface



Rilevamento dimensioni senza contatto
Contactless detection of dimensions.



Bloccaggio ruota automatico
Automatic wheel clamping



Laser runout
Laser runout



Posiz. 4 ruote
4-wheel positioning



Peso nascosto automatico
Hidden weight automatic



Porte USB
USB ports



Carter salvaspazio
Compact wheel guard



Ottimizzazione squilibrio
Imbalance optimization



Weight management
Weight management



Posizionamento automatico
Automatic positioning



Laser puntiforme
Laser point



Illuminatore integrato
LED illuminator



Calibrazione semplificata
Easy Cal



Bloccaggio automatico con tecnologia wireless
Automatic clamping system with wireless technology



Pulsante multifunzione
Multifunction button



Lancio a vel. variabile
Variable speed cycle



3 operatori
3 operators



Piani mobili
Shift plane



Versione con WiNut e colonna porta accessori
Version with WiNut and accessory holder column

1 FULLY AUTOMATIC

Nessuna operazione manuale è richiesta all'operatore.
Tempi di lancio e diagnosi ridotti così da porla sul mercato tra le più veloci in assoluto

*No manual operations required the operator.
Reduced spin and diagnostic times to make it one of the fastest on the market*



DISCOVER

>>



2

TOUCHSCREEN INTERFACE

L'interfaccia grafica e la tecnologia touchscreen **semplificano** e velocizzano le operazioni e la selezione dei programmi di lavoro.

*The **graphic interface** and touchscreen technology **simplify** and speed up operations and work programme selection.*



3

RILEVAMENTO DIMENSIONI RUOTA CON SISTEMA CONTACTLESS - WHEEL DIMENSION MEASUREMENTS WITH CONTACTLESS SYSTEM

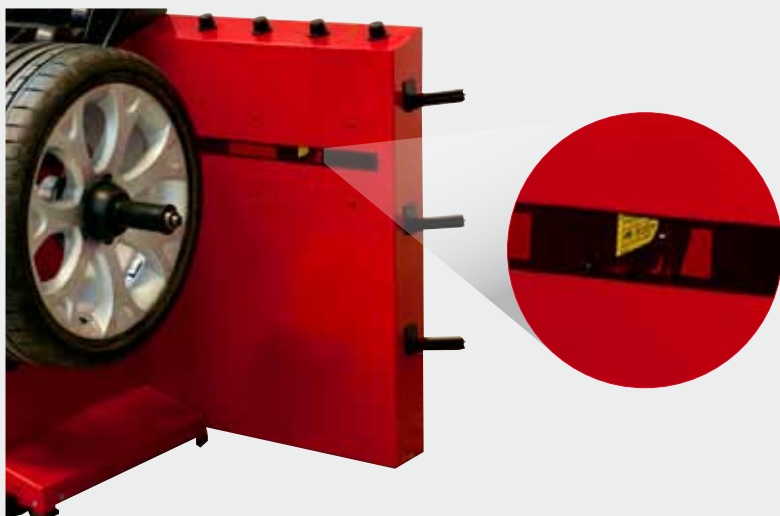

Sensori laser ad alta precisione misurano automaticamente **tutte le dimensioni della ruota in pochissimi secondi** durante il ciclo di misura.

High precision laser sensors automatically measure **all wheel dimensions in a few seconds** during the measurement cycle.



4

POSIZIONAMENTO AUTOMATICO E ILLUMINATORE LED - AUTOMATIC POSITIONING AND LED ILLUMINATOR

A fine lancio la ruota viene frenata e portata automaticamente in posizione di equilibratura (RPA). L'illuminatore led integrato illumina l'area di lavoro per facilitare le operazioni di pulizia del cerchione e l'applicazione dei contrappesi.

At the end of the spin cycle, the wheel is braked and brought automatically into the balancing position (RPA).

*The **integrated LED illuminator** illuminates the work area to facilitate rim cleaning and application of the counterweights.*



5 APPLICAZIONE CONTRAPPESI ADESIVI - ADHESIVE COUNTERWEIGHT APPLICATION

Il laser interno puntiforme indica, con la massima precisione, la posizione di applicazione dei contrappesi adesivi.

The internal point laser indicates the correct position for applying the adhesive counterweights with absolute precision.

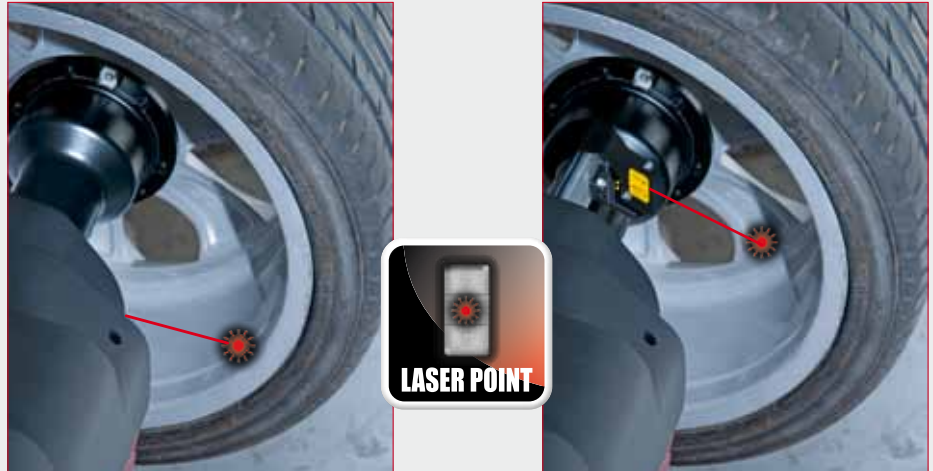

6 HIDDEN WEIGHT AUTOMATIC



Nuovo programma "Hidden Weight" per dividere il peso adesivo di equilibratura del fianco esterno in due pesi equivalenti collocati in posizione nascosta dietro le razze in totale autonomia.

New "Hidden Weight" programme to divide the external side balancing adhesive weight into two equivalent weights hidden behind the spokes. A completely autonomous operation.

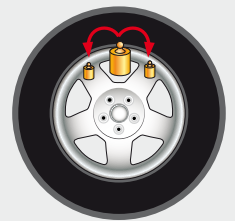

7 RUN-OUT LASER - LASER RUN-OUT MEASUREMENT

Misurazione ad alta precisione delle eccentricità radiali e laterali della ruota (1° armonica e picco-picco) e calcolo del miglior accoppiamento tra le parti risolvendo i tipici problemi di vibrazioni su strada.

High-precision measurement of radial and lateral wheel run-out (1st harmonic and peak-to-peak) and calculation of the best coupling of parts, resolving the typical problems of road vibration.



8 INTELLIGENT POSITIONING LITE



Speciale strumento di diagnosi del treno di ruote del veicolo per verificare eccentricità e squilibri. Una volta memorizzate tutte le ruote, EM 9980 C propone come meglio posizionarle sul veicolo favorendo il comfort e la sicurezza del veicolo.

A special vehicle tyre set diagnostic tool for checking run-out and imbalance. Once all the wheels are memorised, EM 9980 C suggests their best placement on the vehicle placement of the wheels themselves on the vehicle for maximum comfort and safety.



WATCH THE VIDEO



9 BLOCCAGGI RUOTA DISPONIBILI - AVAILABLE WHEEL CLAMPING

A Winut - Basta una semplice pressione sul tasto del manico per essere più veloci e lavorare comodamente.

Non usi più il piede per comandare il sistema di bloccaggio automatico.

Winut - Simply press the button on the sleeve to lock quicker and with less effort than before.

No need to use your foot to operate the automatic clamping system.

B Electronic clamping - Nuovo sistema automatico elettromeccanico di bloccaggio ruota che **riduce i tempi lavoro** e incrementa la precisione di centraggio.

Electronic clamping - New electromechanical system which reduces working times and increases centring precision.

A



2,4 GHz
100 mW



**BREVETTATO
PATENTED**

WATCH THE VIDEO



B



**ELECTRONIC
CLAMPING**

**SEMPLICE DA USARE:
MENO SFORZO,
MENO TEMPO**

**EASY TO USE:
SAVE EFFORT
SAVE TIME**

10



WEIGHT MANAGEMENT

Speciale raccolta di programmi tra cui il LESS WEIGHT che permette di **ridurre i tempi di lavoro (20%)** e la quantità di **contrappesi utilizzati (30%)** incrementando i benefici economici e la salvaguardia dell'ambiente.

Special suite of programmes including LESS WEIGHT, which cuts job times (20%) and reduces the quantity of counterweights used (30%), for more cost-effective, environmentally friendly operation.



11



OPT FLASH

Massima silenziosità di marcia perchè permette di ottimizzare la silenziosità variando la posizione del pneumatico sul cerchio.

Minimises road noise by allowing the operator to alter the position of the tyre on the rim in order to optimise quietness.

12



ONE TOUCH

PULSANTE MULTIFUNZIONE (ONE-TOUCH) E PORTAPESI MULTIFUNCTION (ONE-TOUCH) BUTTON AND WEIGHT TRAY

Pianale portapesi ergonomico e funzionale, dotato di ampie vaschette per le diverse tipologie di contrappesi e il posizionamento degli utensili.

Pulsante multifunzione (one-touch) - Velocizza la selezione dei diversi programmi di lavoro.

Ergonomic and functional weight holder top with large trays for different types of counterweights and tools.

One-Touch multifunction button - Makes the selection of work programmes simpler and quicker.



13



USB UPDATE

PORTE USB - USB PORTS

Porte USB per il collegamento alle periferiche e l'aggiornamento software semplificato.

USB ports for connection to peripheral devices and simplified software upgrades.



14

FRONTALE INCLINATO E CARTER RUOTA SALVASPAZIO SLANTED FRONT AND COMPACT WHEEL GUARD

Frontale inclinato per facilitare l'accesso dell'operatore all'area interna del cerchio.

Carter ruota salvaspazio (brevettato) studiato per permettere il posizionamento a muro dell'equilibratrice e per accogliere ruote fino ad un diametro massimo di 44" (1.118 mm).

Slanted front panel, ensuring operator's easier access to rim inner section



PR ZERO

Compact wheel guard (patented), designed for wheel balancer wall mounting and accommodating wheels up to a max. diameter of 44" (1,118 mm).

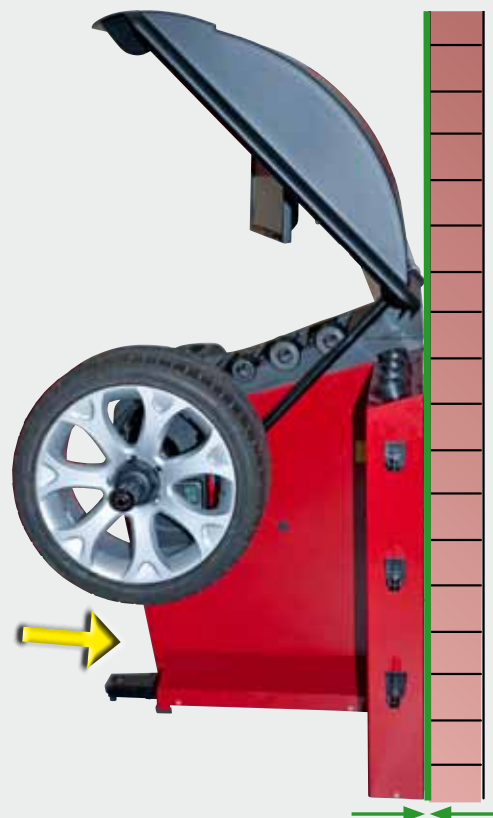

EM9980 C plus

DiagnosticLine



DATI TECNICI

Tensione di alimentazione	115÷230 V 1ph 50/60 Hz
Potenza complessiva assorbita	550 W
Velocità di equilibratura	75-85-98 rpm
Massimo valore di squilibrio	999 g 35,3 oz
Risoluzione	1-5 g 0,0353 - 0,1764 oz
Tempo medio di misura	(ruota da 14kg) 7 s
Diametro albero	40 mm 1,57"
Larghezza cerchio impostabile	1,6" ÷ 23,6"
Diametro cerchio impostabile	2" ÷ 35"
Diametro cerchio misurabile	10" ÷ 32"
Larghezza massima ruota (con protezione)	560 mm 23,6"
Diametro massimo ruota (con protezione)	1118 mm 44"
Distanza flangia di appoggio ruota/macchina	275 mm 10,82"
Frequenza di lavoro dispositivo WINUT	2.4 GHz
Potenza massima del segnale a radiofrequenza	100mW
Peso ruota	75 Kg
Peso macchina	183 kg
Dimensioni massime l x p x h	1453 x 894 x 1884 mm



TECHNICAL DATA

Power supply voltage	115÷230 V 1ph 50/60 Hz
Total power absorption	550 W
Balancing speed	75-85-98 rpm
Maximum imbalance value	999 g 35.3 oz
Resolution	1-5 g 0.0353 - 0.1764 oz
Average measurement time	(14kg wheel) 7 s
Shaft diameter	40 mm 1.57"
Rim width setting range	1.6" ÷ 23.6"
Rim diameter setting range	2" ÷ 35"
Rim diameter measurement range	10" ÷ 32"
Wheel maximum width (with guard)	560 mm 23.6"
Wheel maximum diameter (with guard)	1118 mm 44"
Wheel/machine support flange distance	275 mm 10.82"
WINUT device operation frequency	2.4 GHz
Maximum power of the radiofrequency signal	100mW
Wheel weight	75 Kg
Machine weight	183 kg
Maximum dimensions l x p x h	1453 x 894 x 1884 mm

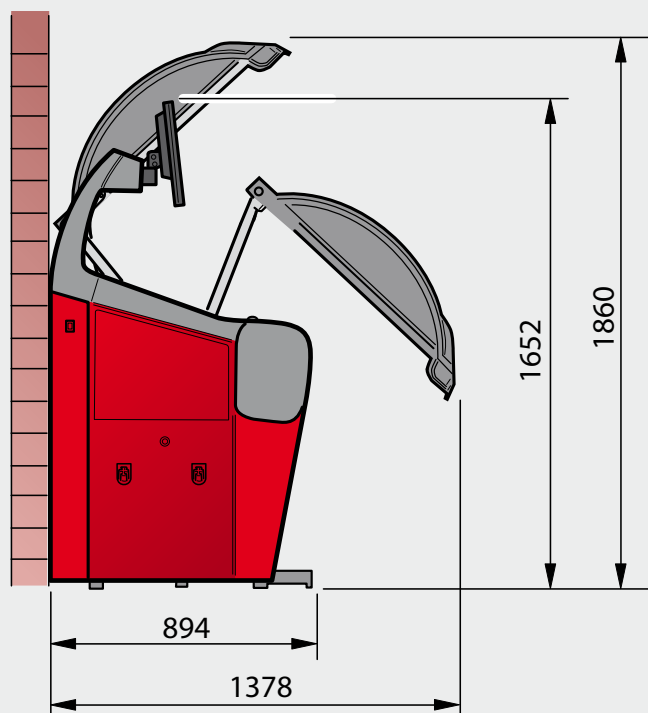
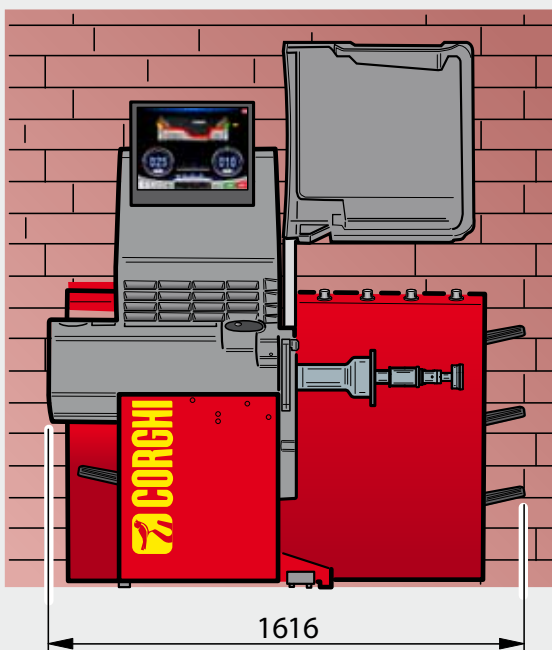

DOTAZIONI - EQUIPMENT

VERSIONI VERSIONS

EM9980 C PLUS

Bloccaggio Ruota Automatico
Automatic Wheel Clamping Version

EM9980 C PLUS



Bloccaggio Ruota WiNut
Winut clamping version



AUTOMATIC CLAMPING SYSTEM



WINUT CLAMPING SYSTEM



ACCESSORI CONSIGLIATI - RECOMMENDED ACCESSORIES



- A** **SOLLEVATORI RUOTA TT-Ø (COD. 8-21100230) e TT-R (COD. 8-21100248)**
Sollevatori ruota "effetto senza peso" TT-Ø (automatico) e TT-R (manuale) che annullano lo sforzo dell'operatore, velocizzano le operazioni quotidiane e garantiscono un centraggio perfetto
TT-Ø (COD. 8-21100230) and TT-R (COD. 8-21100248) WHEEL LIFTERS
"Weightless effect" TT-Ø (automatic) and TT-R (manual) wheel lifters which eliminate operator effort, speed up routine operations and ensure perfect centring
- B** **8-21120005**
Stampante USB A4 a colori getto di inchiostro
con supporto: COD. 8-21100236/90
A4 colour inkjet USB A4 printer set with support: COD. 8-21100236/90
- C** **8-21100244**
HPC Set di 8 boccole bifronte a bassa conicità e alta precisione
HPC, 8 two-faced slightly tapered and high precision bushings

- E** **8-21100253/16**
Colonna di supporto RAL 3002 per 8 boccole bifronte HPC
***Per equilibratrici di colore diverso dal colore standard RAL 3002, utilizzare il codice 8-21100253/90**
RAL 3002 support columns for 8 HPC two-faced bushings
***For balancers in color other than standard RAL 3002, please use: PN. 8-21100253/90**
- F** **8-21100251**
Kit dispenser per contrappesi adesivi
Dispenser kit for adhesive counterweights
- G** **8-21100252**
Bobina contrappesi adesivi. Rotolo in ferro (5 g x 1200 pz)
Adhesive counterweight coil. Iron roll (5 g x 1200 pz)

Fotografie, caratteristiche ed i dati tecnici non sono vincolanti, possono subire modifiche senza preavviso.
The manufacturer reserves the right to modify the features of its products at any time.
Code DPCC00050F 04/2018

Per aiutare il pianeta ottimizzando il consumo di carta, i nostri cataloghi sono consultabili sul sito www.corghi.com. Una stampa responsabile aiuta a preservare l'ambiente. To protect the planet and reduce paper usage, our catalogues are viewable online at the website www.corghi.com. Printing responsibly contributes to saving the environment.



NEXION SPA - ITALY - Società unipersonale soggetta a direzione e coordinamento di Minio srl - A sole shareholder Minio company

www.corghi.com - info@corghi.com

