



EQUIPMENT CATALOGUE
EFFECTIVE
DECEMBER 2017







TYRE CHANGERS
and Original Accessories

REL. JUNE 2018

NEXT RELEASE JULY 2018

The company declines any responsibility for any complaint coming from the use of not original accessories or spares with consequent forfeiture of the CE conformity declaration

COLOR TABLE

RAL 3002		Corghi / Citroen Red	/16
RAL 9007		Mercedes Grey	/37
RAL 7040		Volkswagen / Fiat Grey	/39
RAL 7030		Maserati / Ferrari Grey	/69
RAL 7016		BMW Grey	/34
RAL 5002		Peugeot Blue	/20
RAL 1003		Renault Yellow	/45

Different colors subject to confirmation of the Export dept.

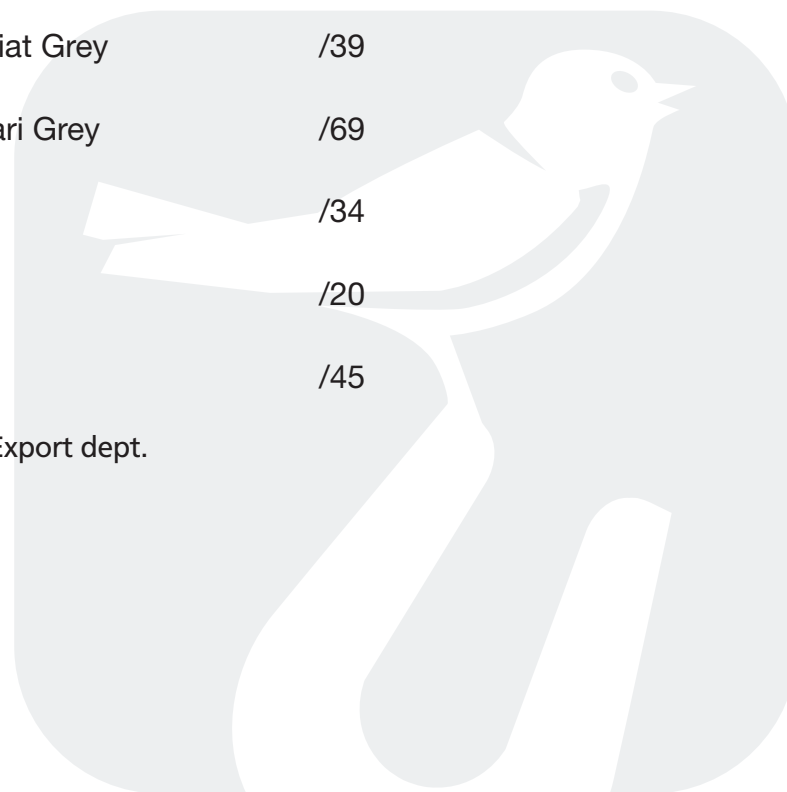

NEW

SUMMARY

DIAGNOSTIC TYRE CHANGERS WITH "LEVA LA LEVA"

TECHNOLOGY

ARTIGLIO UNIFORMITY	4
DIAGNOSTIC TYRE CHANGERS ACCESSORIES	5

LIGHT TYRE CHANGER WITH "LEVA LA LEVA" TECHNOLOGY

ARTIGLIO MASTER CODE	7
ARTIGLIO MASTER 26" MI 2V	8
ARTIGLIO MASTER JOLLY	9
ARTIGLIO MASTER JOLLY AUTOMATIC	10
ARTIGLIO 5000	11
ARTIGLIO 500	12
ARTIGLIO 50	13
ARTIGLIO 55 MOBILE SERVICE	14
A2025 LL	15
ACCESSORIES FOR "LEVA LA LEVA" TYRE CHANGERS	17

TRADITIONAL CAR TYRE CHANGERS

A 2030	35
A 2025	36
A 224	37
A 224 A	38
A 222	39
A 2020	40
A 2015	41
A 2005	42
A 2002	43
ACCESSORIES FOR "TRADITIONAL" TYRE CHANGERS	44

MOTORCYCLE TYRE CHANGERS

BC200 S	62
---------	----

SUPER AUTOMATIC HEAVY-DUTY TYRE CHANGERS WITH "LEVA LA LEVA" TECHNOLOGY

MONSTER AG TT	65
---------------	----

AUTOMATIC HEAVY-DUTY TYRE CHANGERS

AG TT 1600 A	66
HD 1800 HYDRUS	67
HD 1400 EVO	68
HD 1300 A	69
HD 1300 A R RADIO	70
HD 800 A	71

SEMI-AUTOMATIC HEAVY-DUTY TYRE CHANGERS

HD 1400 E EVO	72
HD 1300 BASE	73
HD 1300 R RADIO	74
HD 900	75
HD 700	76
HD 500	77

HEAVY-DUTY TYRE CHANGER FOR MOBILE SERVICE

AGT TILT	78
HD 650 TILT	79
ACCESSORIES FOR "HEAVY-DUTY" TYRE CHANGERS	80

DIAGNOSTIC TYRE CHANGERS WITH "LEVA LA LEVA" TECHNOLOGY

ARTIGLIO UNIFORMITY

STANDARD ACCESSORIES







CODE	ELECTRICAL SUPPLY	DESCRIPTION
0-15100132/16	200-230V / 1P _H / 50-60Hz	Leva La Leva automatic diagnostic tyre changer complete with wheel lifter, bead pressing tool, 22" monitor, centering and locking kit (HPC double face collets), FPF flange with front fingers and holding trolley. Thanks to a pressure pulley , simulating the contact between wheel and road surface, and a laser triangulation for the geometric measuring of rim and tyre, UNIFORMITY indicates the match -mounting (the best positioning of the tyre) and the iPos Intelligent Positioning (the ideal positioning of the four wheels on the vehicle)
0-15100134/00	100-115V / 1P _H / 60Hz	Leva La Leva automatic diagnostic tyre changer complete with wheel lifter, bead pressing tool, 22" monitor, centering and locking kit (HPC double face collets), FPF flange with front fingers and holding trolley. Thanks to a pressure pulley , simulating the contact between wheel and road surface, and a laser triangulation for the geometric measuring of rim and tyre, UNIFORMITY indicates the match -mounting (the best positioning of the tyre) and the iPos Intelligent Positioning (the ideal positioning of the four wheels on the vehicle)

NEW

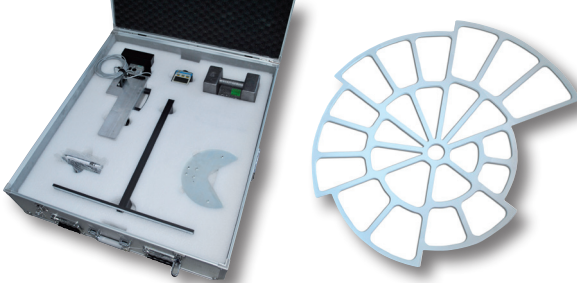





DIAGNOSTIC TYRE CHANGERS ACCESSORIES

	DESCRIPTION	CODE	
	<p>Calibration unit</p>	<p>8-15100010</p>	
	<p>Pick-up rim kit for UNIFORMITY D. 40 mm.</p>	<p>8-15100004</p>	
	<p>Set of 5 columns L=120 mm for flange with front fingers.</p>	<p>8-15100005</p>	
	<p>Set of 5 columns L=80 MMmm for flange with front fingers.</p>	<p>8-15100006</p>	

NEW

DIAGNOSTIC TYRE CHANGERS ACCESSORIES

	DESCRIPTION	CODE	
	Closed centre rims kit for flange with front fingers.	8-15100007	
	Adaptors kit for columns for flange with front fingers (ø 15÷25 mm).	8-15100008	
	Extension kit for wheelbase opening for flange with front fingers.	8-15100009	
	USB inkjet printer.	8-21120005	

NEW

LIGHT TYRE CHANGER WITH "LEVA LA LEVA" TECHNOLOGY

ARTIGLIO MASTER CODE

STANDARD ACCESSORIES

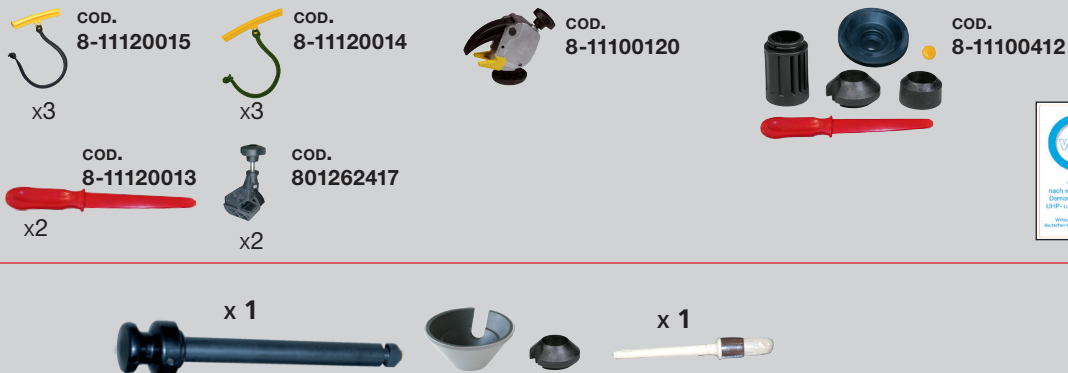

CODE	ELECTRICAL SUPPLY	DESCRIPTION
0-11108502/16	200-230V/1Ph/50-60Hz	"Base" Wheel lifter and bead pressing tool
0-11108518/16	200-230V/1Ph/50-60Hz	"Visual" Wheel lifter and bead pressing tool, camera and Inflatron
0-11108519/16	200-230V/1Ph/50-60Hz	"Visual-L" Wheel and bead pressing tool, camera, Inflatron and lubricator
0-11108522/16	200-230V/1Ph/50-60Hz	"Slide" Wheel lifter and bead pressing tool, lubrication system
0-11108540/16	200-230V/1Ph/50-60Hz	"Inspection" Wheel lifter and bead pressing tool, TPMS, tread depth and temperature probe
0-11108541/16	200-230V/1Ph/50-60Hz	"Inspection-L" Wheel lifter and bead pressing tool, TPMS, tread depth and temperature probe, lubricator
0-11108550/16	200-230V/1Ph/50-60Hz	"Complete" Wheel lifter and bead pressing tool, lubrication system, camera, Inflatron, TPMS, tread depth and temperature probe

NEW



LIGHT TYRE CHANGER WITH "LEVA LA LEVA" TECHNOLOGY

ARTIGLIO MASTER 26" MI 2V

STANDARD ACCESSORIES



COD.
801261060



x2

COD.
8012622417



COD.
8-11100401



CODE	ELECTRICAL SUPPLY	DESCRIPTION
0-11103602/16	230V / 1Ph / 50-60Hz	ARTIGLIO MASTER 26" "Standard"
0-11103632/16	230V / 1Ph / 50-60Hz	ARTIGLIO MASTER 26" Wheel lifter
0-11103607/16	230V / 1Ph / 50-60Hz	ARTIGLIO MASTER 26" Wheel lifter, Inflatron
0-11103612/16	230V / 1Ph / 50-60Hz	ARTIGLIO MASTER 26" Wheel lifter, T.I
0-11103627/16	230V / 1Ph / 50-60Hz	ARTIGLIO MASTER 26" Wheel lifter, T.I., Inflatron

NEW



LIGHT TYRE CHANGER WITH "LEVA LA LEVA" TECHNOLOGY

ARTIGLIO MASTER JOLLY

STANDARD ACCESSORIES

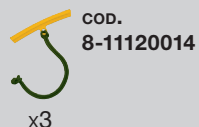
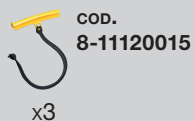

CODE	ELECTRICAL SUPPLY	DESCRIPTION
0-11116202/16	200-230V / 1P _H / 50-60Hz	ARTIGLIO MASTER JOLLY
0-11116212/16	200-230V / 1P _H / 50-60Hz	ARTIGLIO MASTER JOLLY with bead pressing tool BPT
0-11116232/16	200-230V / 1P _H / 50-60Hz	ARTIGLIO MASTER JOLLY with bead pressing tool BPT and lifter
0-11116242/16	200-230V / 1P _H / 50-60Hz	ARTIGLIO MASTER JOLLY with bead pressing tool BPT, lifter and T.I.

NEW



LIGHT TYRE CHANGER WITH "LEVA LA LEVA" TECHNOLOGY

ARTIGLIO MASTER JOLLY AUTOMATIC

STANDARD ACCESSORIES



COD.
801261060

x2



COD.
8012622417

x3



COD.
8-11120015

x3



COD.
8-11120014



cod. 8-11100401

x2

x2

x3

x5

x 1



CODE	ELECTRIC SUPPLY	DESCRIPTION
0-11117702/16	200-230V / 1Ph / 50-60Hz	ARTIGLIO MASTER JOLLY AUTOMATIC
0-11117712/16	200-230V / 1Ph / 50-60Hz	ARTIGLIO MASTER JOLLY AUTOMATIC with bead pressing tool BPT
0-11117732/16	200-230V / 1Ph / 50-60Hz	ARTIGLIO MASTER JOLLY AUTOMATIC with bead pressing tool BPT and lifter
0-11117742/16	200-230V / 1Ph / 50-60Hz	ARTIGLIO MASTER JOLLY AUTOMATIC with bead pressing tool BPT, lifter and T.I.

NEW



LIGHT TYRE CHANGER WITH "LEVA LA LEVA" TECHNOLOGY

ARTIGLIO 5000

STANDARD ACCESSORIES

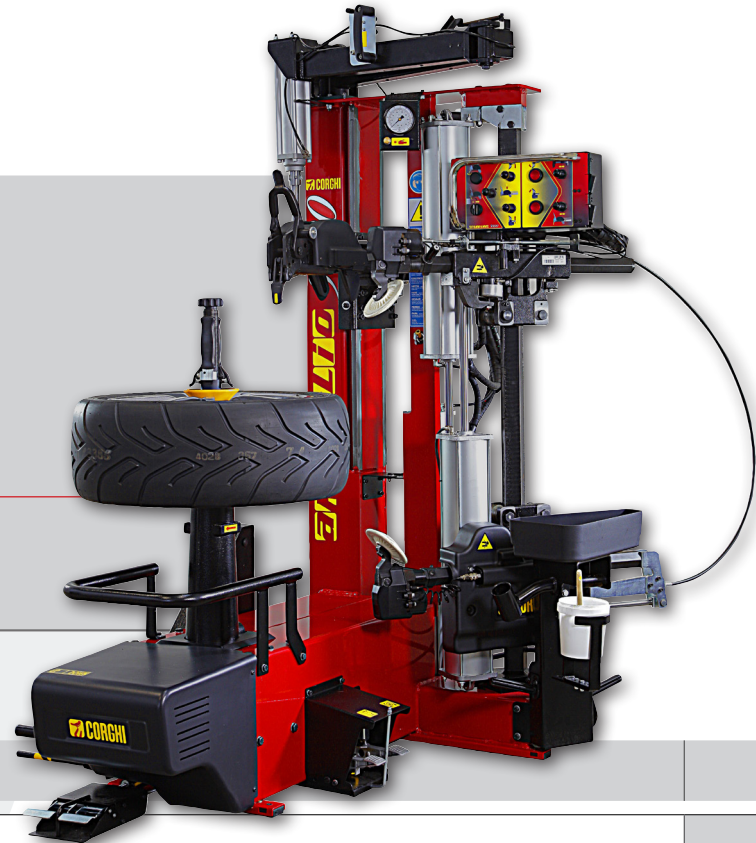

CODE	ELECTRIC SUPPLY	DESCRIPTION
0-11118812/16	200-230V / 1P _H / 50-60Hz	ARTIGLIO 5000 2V MI with bead pressing tool
0-11118832/16	200-230V / 1P _H / 50-60Hz	ARTIGLIO 5000 2V MI with bead pressing tool and wheel lifter
0-11118842/16	200-230V / 1P _H / 50-60Hz	ARTIGLIO 5000 2V MI with bead pressing tool and wheel lifter and T.I.
0-11118814/16	115V / 1P _H / 50-60Hz	ARTIGLIO 5000 2V MI with bead pressing tool
0-11118834/16	115V / 1P _H / 50-60Hz	ARTIGLIO 5000 2V MI with bead pressing tool and wheel lifter
0-11118844/16	115V / 1P _H / 50-60Hz	ARTIGLIO 5000 2V MI with bead pressing tool and wheel lifter and T.I.

NEW



LIGHT TYRE CHANGER WITH "LEVA LA LEVA" TECHNOLOGY

ARTIGLIO 500

STANDARD ACCESSORIES

 COD. 8-11400293
x5 x10

 COD. 801262417
x2

 COD. 801261060

 COD. 8-11100400



 x 1



CODE	ELECTRICAL SUPPLY	DESCRIPTION
0-11108232/16	200-230V / 1P _H / 50-60Hz	ARTIGLIO 500 2V with wheel lifter
0-11108234/16	115V / 1P _H / 50-60Hz	ARTIGLIO 500 2V with wheel lifter

NEW



LIGHT TYRE CHANGER WITH "LEVA LA LEVA" TECHNOLOGY

ARTIGLIO 50

STANDARD ACCESSORIES



CODE	ELECTRICAL SUPPLY	DESCRIPTION
0-11105002/16	200-230V / 1Ph / 50-60Hz	ARTIGLIO 50 MI 2V Standard
0-11105012/16	200-230V / 1Ph / 50-60Hz	ARTIGLIO 50 MI 2V with wheel lifter and T.I.
0-11105032/16	200-230V / 1Ph / 50-60Hz	ARTIGLIO 50 MI 2V with wheel lifter

NEW

CORGHI

LIGHT TYRE CHANGER WITH "LEVA LA LEVA" TECHNOLOGY

ARTIGLIO 55 MOBILE SERVICE

STANDARD ACCESSORIES

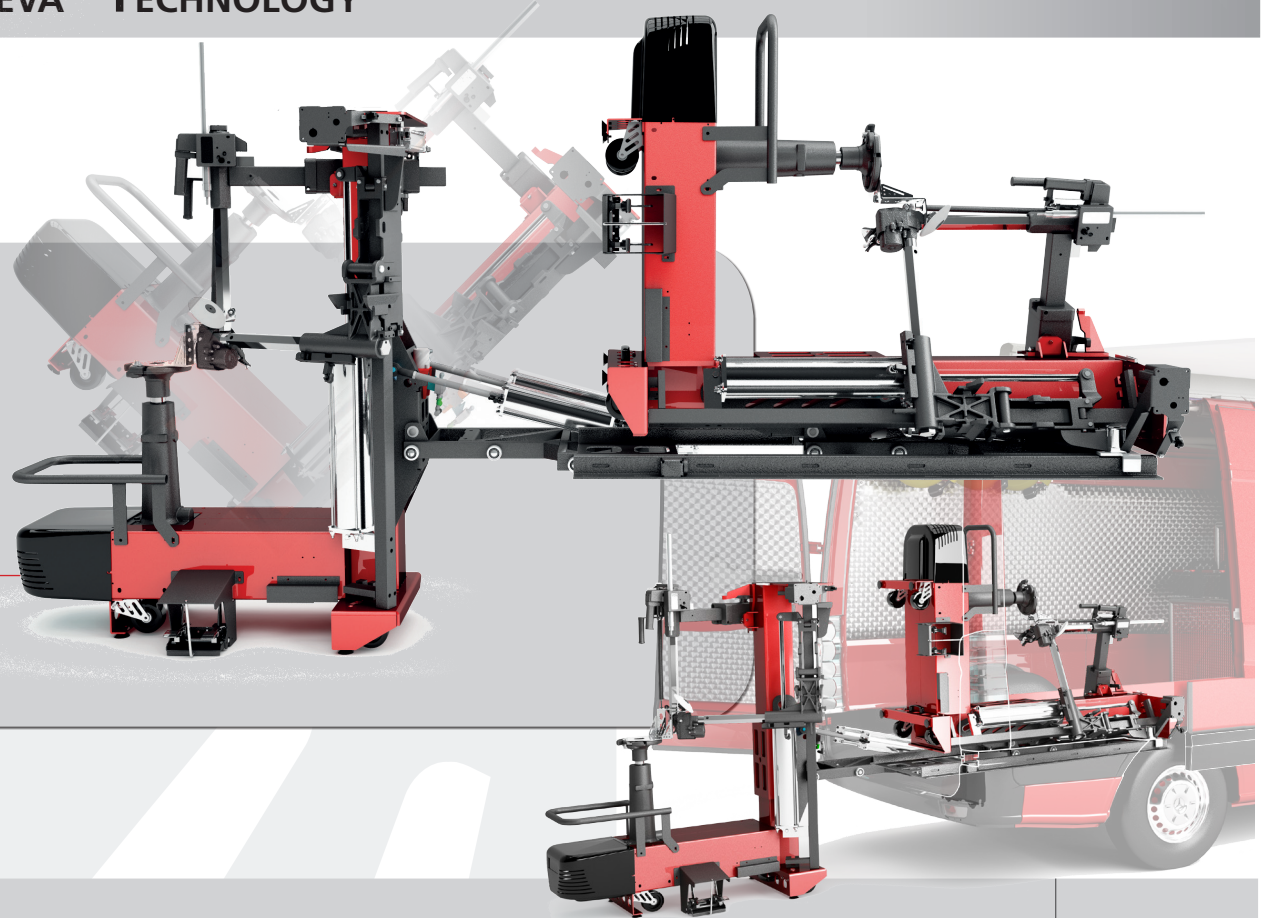

CODE	ELECTRICAL SUPPLY	DESCRIPTION
0-11117202/16	200-230V / 1P _H / 50-60Hz	ARTIGLIO 55 Mobile service - slide system included)
8-51100038		Components for power unit (battery pack, 48V- 6Kw inverter + remote control, inverter 12V-1,5Kw + remote control + battery charger, air reservoir, rotary compressor)
8-51100060		Components for power unit without air reservoir (battery pack + battery charger, 48V-6Kw inverter, inverter 12V-1,5Kw, warning remote control inverter status, rotary compressor)

NEW

CORGI

LIGHT TYRE CHANGER WITH "LEVA LA LEVA" TECHNOLOGY

A2025 LL

STANDARD ACCESSORIES



CODE	ELECTRICAL SUPPLY	DESCRIPTION
0-11109501/16	400V / 3P _H / 50Hz	A2025 LL 24"
0-11109502/16	200-230V / 1P _H / 50Hz	A2025 LL 24"
0-11109504/16	115V / 1P _H / 60Hz	A2025 LL 24"
0-11109511/16	200-230V / 3P _H / 60Hz	A2025 LL 24"
0-11109512/16	200-230V / 1P _H / 60Hz	A2025 LL 24"
0-11109521/16	200-230V / 3P _H / 50Hz	A2025 LL 24"
0-11109401/16	400V / 3P _H / 50Hz	A2025 LL T.I. 24"
0-11109402/16	200-230V / 1P _H / 50Hz	A2025 LL T.I. 24"

NEW







LIGHT TYRE CHANGER WITH "LEVA LA LEVA" TECHNOLOGY

CODE	ELECTRICAL SUPPLY	DESCRIPTION
0-11109412/16	200-230V / 1P _H / 60Hz	A2025 LL T.I. 24"
0-11109414/16	115V / 1P _H / 60Hz	A2025 LL T.I. 24"
0-11109421/16	200-230V / 3P _H / 50Hz	A2025 LL T.I. 24"
0-11109441/16	200-230V / 3P _H / 60Hz	A2025 LL T.I. 24"
0-11109542/16	200-230V / 1P _H / 50-60Hz	A2025 LL 2V MI 24"
0-11109522/16	200-230V / 1P _H / 50-60Hz	A2025 LL 2V MI 24" with SP2300 and WDK kit 04-016
0-11109582/16	200-230V / 1P _H / 50-60Hz	A2025 LL 2V MI 24" with SP3000 and WDK kit 04-014
0-11109592/16	200-230V / 1P _H / 50-60Hz	A2025 LL 2V MI 24" with SP2000 and WDK kit 04-013
0-11109462/16	200-230V / 1P _H / 50-60Hz	A2025 LL 2V T.I. MI 24"
0-11109482/16	200-230V / 1P _H / 50-60Hz	A2025 LL 2V T.I. MI 24" with SP3000 and WDK kit 04-014
0-11109492/16	200-230V / 1P _H / 50-60Hz	A2025 LL 2V T.I. MI 24" with SP2000 and WDK kit 04-013
0-11109422/16	200-230V / 1P _H / 50-60Hz	A2025 LL 2V T.I. MI 24" with SP2300 and WDK kit 04-016
0-11109452/16	200V / 1P _H / 60Hz	A2025 LL T.I. MI 24" with PIT CTM

NEW



ACCESSORIES FOR "LEVA LA LEVA" TYRE CHANGERS





ACCESSORIES FOR "LEVA LA LEVA" TYRE CHANGERS				A. MASTER CODE	A. MASTER 26	A. MASTER JOLLY	A. MASTER JOLLY AUTOMATIC	A. 5000	A. 500	A. 50	A. 55	A2025 LL*
	DESCRIPTION	CODE										
	TPM-02 Device for checking operation of TPMS sensors	0-51100502		○	○	○	○	○	○	○	○	○
	EOBD kit	8-51120002		○	○	○	○	○	○	○	○	○
	TPM02+Kit EOBD	0-51100701		○	○	○	○	○	○	○	○	○
	Subscription 12M TPM-02 standard	8-51100029		○	○	○	○	○	○	○	○	○
	Subscription 12M TPM-02 extended	8-51120003		○	○	○	○	○	○	○	○	○
	Subscription 12M TPM-02 + EOBD	8-51120001		○	○	○	○	○	○	○	○	○
	Subscription 12M TPM-02 + EOBD extended	8-51120004		○	○	○	○	○	○	○	○	○

NEW

■ = Standard ○ = Compatible - = NOT compatible

* for the other accessories consult the TRADITIONAL TYRE CHANGERS section

ACCESSORIES FOR "LEVA LA LEVA" TYRE CHANGERS

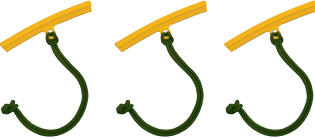

	DESCRIPTION	CODE		A. MASTER CODE	A. MASTER 26	A. MASTER JOLLY	A. MASTER JOLLY AUTOMATIC	A. 5000	A. 500	A. 50	A. 55	A2025 LL*
	Bluetooth printer	8-51100035		○	○	○	○	○	○	○	○	○
	Cable for printer (USB -> RS232)	8-51100036		○	○	○	○	○	○	○	○	○
	Barcode reader	8-51100037		○	○	○	○	○	○	○	○	○
	PTS -Tyre brad protection (red)	8-11120013		○	○	○	○	■	○	○	○	■
	REP - 3 rim edge plastic protections (yellow)	8-11120014		■	○	■	■	■	○	○	○	■

NEW

■ = Standard ○ = Compatible - = NOT compatible

* for the other accessories consult the TRADITIONAL TYRE CHANGERS section

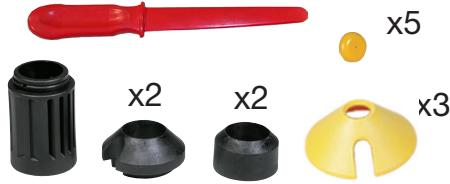
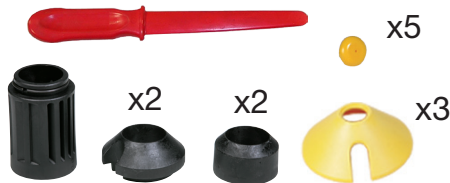
ACCESSORIES FOR "LEVA LA LEVA" TYRE CHANGERS



	DESCRIPTION	CODE	A. MASTER CODE	A. MASTER 26	A. MASTER JOLLY	A. MASTER JOLLY AUTOMATIC	A. 5000	A. 500	A. 50	A. 55	A2025 LL*
	REPS - 3 rim edge short plastic protectionn (yellow)	8-11120015	■	○	■	■	■	○	○	○	○
	Protections kit for manual locking	8-11100400	-	-	■	-	■	■	■	■	-
	Protections kit for automatic locking Master 26, Master Jolly Automatic.	8-11100401	-	■	-	■	-	-	-	-	-
	Protections kit for automatic locking Master Code	8-11100412	■	-	-	-	-	-	-	-	-
	Spare kit of leverless tool head plastic protectionn (for Artiglio 50/55 and A 2025 LL up to s/n CMG143866)	8-11400293	-	-	-	-	-	■	■	■	■

NEW

■ = Standard ○ = Compatible - = NOT compatible

* for the other accessories consult the TRADITIONAL TYRE CHANGERS section

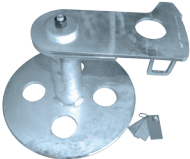
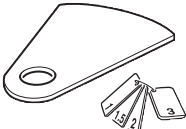
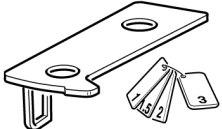
ACCESSORIES FOR "LEVA LA LEVA" TYRE CHANGERS

	DESCRIPTION	CODE		A. MASTER CODE	A. MASTER 26	A. MASTER JOLLY	A. MASTER JOLLY AUTOMATIC	A. 5000	A. 500	A. 50	A. 55	A2025 LL*
	Plastic protection kit for "Leva La Leva" V3 head tool (starting from serial number CMG143867)	8-11400325		-	-	-	-	-	-	■	■	■
	Adjustment kit for LL head tool	8-11100296		-	-	-	-	-	-	-	-	○
	Dima Template kit for head tool	8-11100187		-	○	○	○	-	-	-	-	-
	DIMA Template kit for head tool adjustment	8-11100125		-	-	-	-	-	-	○	○	-
	Mounting/Demounting head assembly	8-11100177		-	-	-	-	-	-	○	-	-

NEW

■ = Standard ○ = Compatible - = NOT compatible

* for the other accessories consult the TRADITIONAL TYRE CHANGERS section

ACCESSORIES FOR "LEVA LA LEVA" TYRE CHANGERS

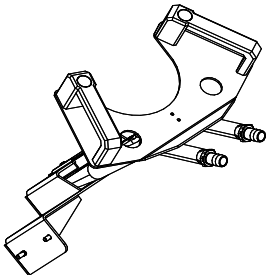
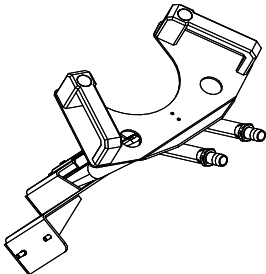



	DESCRIPTION	CODE		A. MASTER CODE	A. MASTER 26	A. MASTER JOLLY	A. MASTER JOLLY AUTOMATIC	A. 5000	A. 500	A. 50	A. 55	A2025 LL*
	T.I. system kit	8-11100289		○	-	-	-	-	-	-	-	-
	T.I. system kit	801260961		-	○	○	○	-	-	-	-	-
	T.I. ASME kit (for USA only)	8-11100317		○	-	-	-	-	-	-	-	-
	T.I. system kit	8-11100111		-	-	-	-	-	○	○	○	-
	T.I. System kit	8-11120053		-	-	-	-	○	-	-	-	-
	T.I. Asme kit (for U.S.A. and Canada only)	8-11120054		-	-	-	-	○	-	-	-	-

NEW

■ = Standard ○ = Compatible - = NOT compatible

* for the other accessories consult the TRADITIONAL TYRE CHANGERS section

ACCESSORIES FOR "LEVA LA LEVA" TYRE CHANGERS







ACCESSORIES FOR "LEVA LA LEVA" TYRE CHANGERS				A. MASTER CODE	A. MASTER 26	A. MASTER JOLLY	A. MASTER JOLLY AUTOMATIC	A. 5000	A. 500	A. 50	A. 55	A2025 LL*
	DESCRIPTION	CODE										
	Universal flange for special and closed centre rims	8-11100087		○	-	○	-	○	○	○	○	-
	Universal flange for special and closed centre rims	8-11100038		-	○	-	○	-	-	-	-	-
	Reverse wheel flange	8-11100039		○	○	○	○	○	○	○	○	-
	Extension kit for reverse wheel flange, flange for close centre rims and non standard wheel kit	8-11100046		○	○	○	○	○	○	○	○	-
	Set of 6 "SHORT" extensions	8-11100244		○	○	○	○	○	○	○	○	-

NEW

■ = Standard ○ = Compatible - = NOT compatible

* for the other accessories consult the TRADITIONAL TYRE CHANGERS section

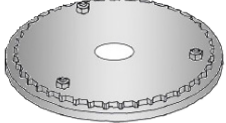
ACCESSORIES FOR "LEVA LA LEVA" TYRE CHANGERS



	DESCRIPTION	CODE		A. MASTER CODE	A. MASTER 26	A. MASTER JOLLY	A. MASTER JOLLY AUTOMATIC	A. 5000	A. 500	A. 50	A. 55	A2025 LL *
	Set of 6 "EXTRA SHORT" extensions	8-11100245		0	0	0	0	0	0	0	0	-
	Set of 6 "LONG" extensions	8-11100246		0	0	0	0	0	0	0	0	-
	Set of 6 spherical extensions for new Audi type rims	8-11100291		0	0	0	0	0	0	0	0	-
	Set of 12 plastic guards for extensions	8-11100284		0	0	0	0	0	0	0	0	-
	Wire wheels kit	8-11100009		0	0	0	0	-	-	-	-	-
	Pick-up rim kit 26"	8-11100037		0	0	-	0	-	-	-	-	-

NEW

■ = Standard ○ = Compatible - = NOT compatible

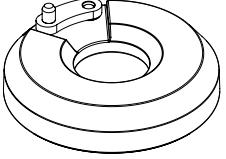

ACCESSORIES FOR "LEVA LA LEVA" TYRE CHANGERS

	DESCRIPTION	CODE		A. MASTER CODE	A. MASTER 26	A. MASTER JOLLY	A. MASTER JOLLY AUTOMATIC	A. 5000	A. 500	A. 50	A. 55	A2025 LL*
	Special adapter kit (H=28mm) for high rims	8-15100003		-	○	○	○	○	-	-	-	-
	Pick-up rim kit	8-11100086		-	-	○	-	○	○	○	○	-

NEW

■ = Standard ○ = Compatible - = NOT compatible

* for the other accessories consult the TRADITIONAL TYRE CHANGERS section

ACCESSORIES FOR "LEVA LA LEVA" TYRE CHANGERS

ACCESSORIES FOR "LEVA LA LEVA" TYRE CHANGERS			A. MASTER CODE	A. MASTER 26	A. MASTER JOLLY	A. MASTER JOLLY AUTOMATIC	A. 5000	A. 500	A. 50	A. 55	A2025 LL*	
DESCRIPTION			CODE									
<p>Cerchi ciechi / Close centre rim - - - - - Cerchi rovesci / Reverse rim ————</p>			Not standard rim kit	8-11100040	-	○	-	○	-	-	-	-
38	Ring nut	4-102377										
39	Columns with locking device	5-102721										
40	Columns with locking device	5-102720										
36	Universal flange	5-102421										
41	Rim fixing screw	361647										
42	Rim fixing ring nut	361648										
43	Exagonal bar	4-102372										
44	Connecting rod	4-107023										
35	Hole detector	441286										
60	Fixing screw for connecting rod	4-101250										

NEW

■ = Standard ○ = Compatible - = NOT compatible

* for the other accessories consult the TRADITIONAL TYRE CHANGERS section

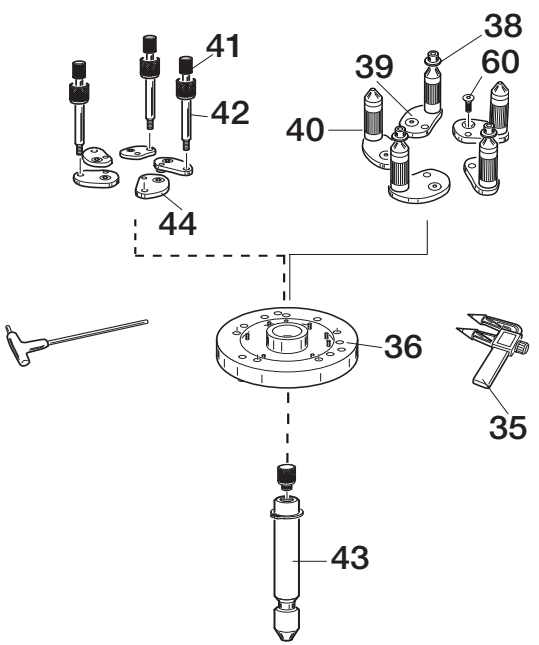

ACCESSORIES FOR "LEVA LA LEVA" TYRE CHANGERS

ACCESSORIES FOR "LEVA LA LEVA" TYRE CHANGERS			A. MASTER CODE	A. MASTER 26	A. MASTER JOLLY	A. MASTER JOLLY AUTOMATIC	A. 5000	A. 500	A. 50	A. 55	A2025 LL*	
DESCRIPTION			CODE									
 <p>Cerchi ciechi / Close centre rim Cerchi rovesci / Reverse rim</p>			Not standard rim kit	8-11100110	O	-	O	-	O	O	O	O
38	Ring nut	4-102377										
39	Columns with locking device	5-102721										
40	Columns with locking device	5-102720										
36	Universal flange	5-102421										
41	Rim fixing screw	361647										
42	Rim fixing ring nut	361648										
43	Exagonal bar	4-102372										
44	Connecting rod	4-107023										
35	Hole detector	441286										
60	Fixing screw for connecting rod	4-101250										





NEW

■ = Standard ○ = Compatible - = NOT compatible

* for the other accessories consult the TRADITIONAL TYRE CHANGERS section



ACCESSORIES FOR "LEVA LA LEVA" TYRE CHANGERS





ACCESSORIES FOR "LEVA LA LEVA" TYRE CHANGERS				A. MASTER CODE	A. MASTER 26	A. MASTER JOLLY	A. MASTER JOLLY AUTOMATIC	A. 5000	A. 500	A. 50	A. 55	A2025 LL*
	DESCRIPTION	CODE										
	Pneumatic bead pressing tool	801263408		-	○	○	○	-	-	-	-	-
	Pneumatic bead pressing tool	8-11100221		-	-	-	-	-	○	-	-	-
	Pneumatic bead pressing tool	8-11100097		-	-	-	-	-	-	○	○	-
	Bead pressing clamp for Run Flat tyres	801262417		■	■	■	■	■	■	■	■	■

NEW

■ = Standard ○ = Compatible - = NOT compatible

* for the other accessories consult the TRADITIONAL TYRE CHANGERS section

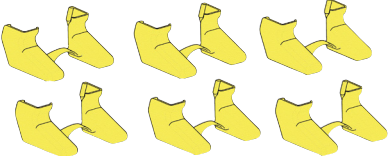
ACCESSORIES FOR "LEVA LA LEVA" TYRE CHANGERS





ACCESSORIES FOR "LEVA LA LEVA" TYRE CHANGERS				A. MASTER CODE	A. MASTER 26	A. MASTER JOLLY	A. MASTER JOLLY AUTOMATIC	A. 5000	A. 500	A. 50	A. 55	A2025 LL*
	DESCRIPTION	CODE										
	Plastic bead pressing clamp	801435685		-	○	-	○	○	○	-	-	○
	Sliding bead pressing clamp	8-11100120		■	○	○	○	○	○	○	○	○
	6 plastic protections for code 8-11100120	8-11100126		■	○	○	○	○	○	○	○	○
	Plastic bead pressing lever with cord	801261910		-	○	○	○	○	○	○	○	○
 x10	REGLETTE" 10 plastic Pax System protections	801260235		○	○	○	○	○	○	○	○	○

NEW

■ = Standard ○ = Compatible - = NOT compatible

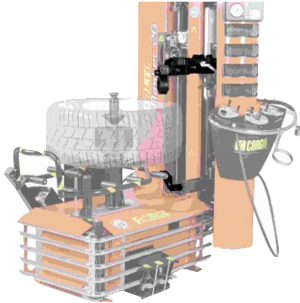
* for the other accessories consult the TRADITIONAL TYRE CHANGERS section

ACCESSORIES FOR "LEVA LA LEVA" TYRE CHANGERS





ACCESSORIES FOR "LEVA LA LEVA" TYRE CHANGERS				A. MASTER CODE	A. MASTER 26	A. MASTER JOLLY	A. MASTER JOLLY AUTOMATIC	A. 5000	A. 500	A. 50	A. 55	A2025 LL*
	DESCRIPTION	CODE										
	Pax System kit	801260860		-	O	-	-	-	-	-	-	-
	Pax System kit	8-11100338		-	-	-	-	-	O	-	-	-
	Pax System kit	8-11100118		-	-	-	-	-	-	O	O	-
	Updating kit for bead penetration	8-11100167		-	-	-	-	-	-	O	O	-

NEW

■ = Standard ○ = Compatible - = NOT compatible

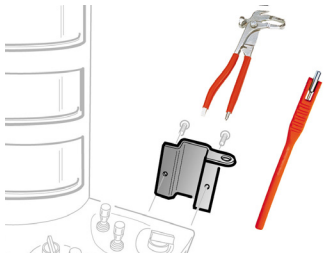
* for the other accessories consult the TRADITIONAL TYRE CHANGERS section

ACCESSORIES FOR "LEVA LA LEVA" TYRE CHANGERS



	DESCRIPTION	CODE		A. MASTER CODE	A. MASTER 26	A. MASTER JOLLY	A. MASTER JOLLY AUTOMATIC	A. 5000	A. 500	A. 50	A. 55	A2025 LL*
	Metal holder complete with weight pliers and valve lever	801263126		-	o	-	-	-	-	-	-	-
	Valve score screwdriver	801461005		o	o	o	o	o	o	o	o	o
	Universal grease bucket holder 3.5-5kg	801261060		-	■	-	■	■	■	■	■	-
	Socolub v0690 ex BIB-UP (liquid lubricator for bead breaker - 5Lt)	3-00504		o	-	-	-	-	-	-	-	-
	AUTOLOCK II automatic clamping	8-11100237		-	-	o	-	o	o	o	o	-

NEW

■ = Standard o = Compatible - = NOT compatible

* for the other accessories consult the TRADITIONAL TYRE CHANGERS section

ACCESSORIES FOR "LEVA LA LEVA" TYRE CHANGERS

	DESCRIPTION	CODE		A. MASTER CODE	A. MASTER 26	A. MASTER JOLLY	A. MASTER JOLLY AUTOMATIC	A. 5000	A. 500	A. 50	A. 55	A2025 LL*
	Wheel lifter kit	8-11100398		-	-	o	o	-	-	-	-	-
	Wheel lifter kit	8-11100085		-	-	-	-	-	-	o	-	-

NEW

■ = Standard o = Compatible - = NOT compatible

* for the other accessories consult the TRADITIONAL TYRE CHANGERS section

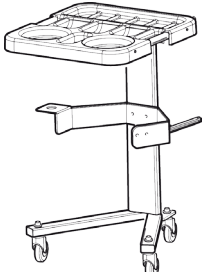

ACCESSORIES FOR "LEVA LA LEVA" TYRE CHANGERS

ACCESSORIES FOR "LEVA LA LEVA" TYRE CHANGERS												
	DESCRIPTION	CODE		A. MASTER CODE	A. MASTER 26	A. MASTER JOLLY	A. MASTER JOLLY AUTOMATIC	A. 5000	A. 500	A. 50	A. 55	A2025 LL *
	Wheel lifter	8-11120052		-	-	-	-	O	-	-	-	-
	Easytrolley - tools and accessories holder trolley	0-51100101/16		O	O	O	O	O	O	O	O	O
	Easytrolley T.I. - tools and accessories holder trolley with tubeless system (T.I.)	0-51100102/16		O	O	O	O	O	O	O	O	O







NEW

■ = Standard ○ = Compatible - = NOT compatible

* for the other accessories consult the TRADITIONAL TYRE CHANGERS section



ACCESSORIES FOR "LEVA LA LEVA" TYRE CHANGERS

		DESCRIPTION	CODE	A. MASTER CODE	A. MASTER 26	A. MASTER JOLLY	A. MASTER JOLLY AUTOMATIC	A. 5000	A. 500	A. 50	A. 55	A2025 LL*	
 x4	<i>Power Unit - Artiglio 55 Mobile Service</i>		8-51100038	-	-	-	-	-	-	-	■	-	
	Battery pack (4 pcs)			-	-	-	-	-	-	-	-	■	-
 x2	Remote control			-	-	-	-	-	-	-	-	■	-
	Inverter 1Ph - 1 kW			-	-	-	-	-	-	-	-	■	-
	Inverter 1Ph - 6 kW			-	-	-	-	-	-	-	-	■	-
	Electric box with connecting cable			-	-	-	-	-	-	-	-	■	-
	Air reservoir (80l) with pneumatic components			-	-	-	-	-	-	-	-	■	-
	Rotary compressor			-	-	-	-	-	-	-	-	■	-

NEW

■ = Standard ○ = Compatible - = NOT compatible

* for the other accessories consult the TRADITIONAL TYRE CHANGERS section

TRADITIONAL CAR TYRE CHANGERS

A 2030

STANDARD ACCESSORIES

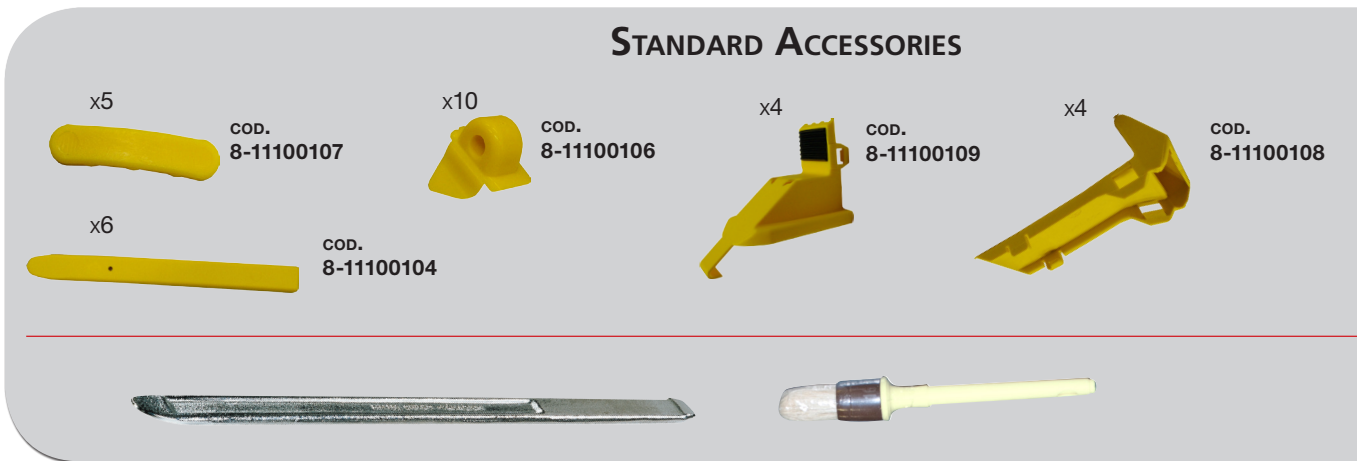

CODE	ELECTRICAL SUPPLY	DESCRIPTION
0-11101352/16	200-230V/1Ph/50-60Hz	A 2030 26" MI 2V
0-11101454/16	115V/1Ph/50-60Hz	A 2030 TI 26" MI 2V
0-11101462/16	200-230V/1Ph/50-60Hz	A 2030 TI 26" MI 2V
0-11101422/16	200-230V/1Ph/50-60Hz	A 2030 TI 26" MI 2V with SP3000 and WDK kit 04-008
0-11101452/16	200-230V/1Ph/50-60Hz	A 2030 TI 26" MI 2V with SP2000 and WDK kit 04-005

NEW



TRADITIONAL CAR TYRE CHANGERS

A 2025

STANDARD ACCESSORIES



CODE	ELECTRICAL SUPPLY	DESCRIPTION
0-11101101/16	400V / 3P _H / 50Hz	A 2025 24"
0-11101102/16	200-230V / 1P _H / 50Hz	A 2025 24"
0-11101121/16	200-230V / 3P _H / 50Hz	A 2025 24"
0-11101111/16	200-230V / 3P _H / 60Hz	A 2025 24"
0-11101151/16	400V / 3P _H / 60Hz	A 2025 24"
0-11101201/16	400V / 3P _H / 50Hz	A 2025 24" T.I.
0-11101241/16	200-230V / 3P _H / 50-60Hz	A 2025 24" T.I.
0-11101221/16	200-230V / 3P _H / 50Hz	A 2025 24" T.I.
0-11101202/16	200-230V / 1P _H / 50Hz	A 2025 24" T.I.
0-11101212/16	200-230V / 1P _H / 50-60Hz	A 2025 24" T.I.
0-11101267/16	115V / 1P _H / 60Hz	A 2025 24" T.I. ASME
0-11101142/16	200-230V / 1P _H / 50-60Hz	A 2025 24" MI 2V
0-11101262/16	200-230V / 1P _H / 50-60Hz	A 2025 24" MI 2V T.I.
0-11101205/16	AIR MOTOR	A 2025 24" T.I. AIR M
0-11101223/16	200-230V / 3P _H / 50Hz	A 2025 24" MI 2V T.I. with SP2300 + WDK kit (04 - 017)
0-11101282/16	200-230V / 1P _H / 50-60Hz	A 2025 24" MI 2V T.I. with SP3000 + WDK kit (04 - 007)
0-11101292/16	200-230V / 1P _H / 50-60Hz	A 2025 24" MI 2V T.I. with SP2000 + WDK kit (04- 004)

NEW



TRADITIONAL CAR TYRE CHANGERS

A 224

STANDARD ACCESSORIES

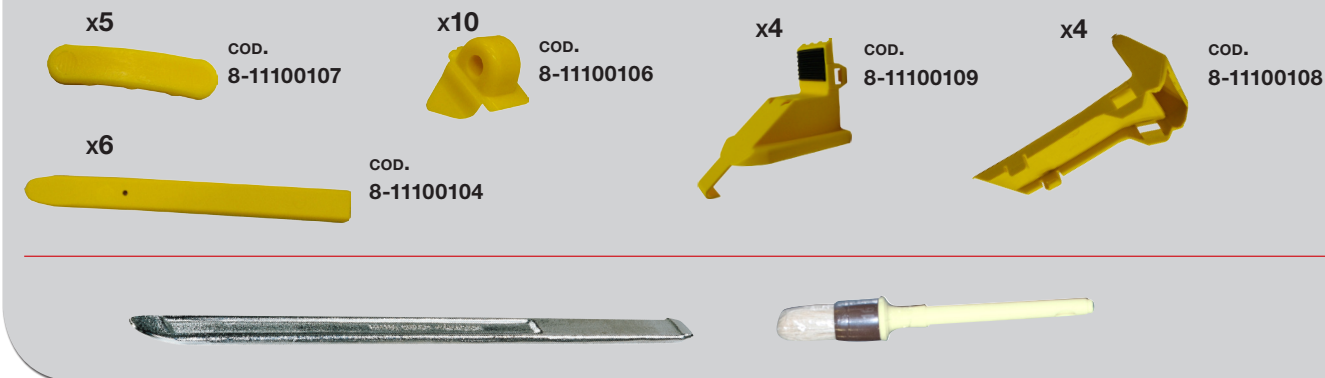

CODE	ELECTRICAL SUPPLY	DESCRIPTION
0-11115901/16	400V / 3P _H / 50Hz	A 224 24"
0-11115902/16	230V / 1P _H / 50Hz	A 224 24"
0-11115911/16	200-230V / 3P _H / 60Hz	A 224 24"
0-11115932/16	200-230V / 1P _H / 50-60Hz	A 224 24" MI 2V
0-11115941/16	400V / 3P _H / 50Hz	A 224 24" 2V
0-11115951/16	200-230V / 3P _H / 60Hz	A 224 24" 2V
0-11116001/16	400V / 3P _H / 50Hz	A 224 24" T.I.
0-11116002/16	230V / 1P _H / 50Hz	A 224 24" T.I.
0-11116011/16	200-230V / 3P _H /60Hz	A 224 24" T.I.
0-11116012/16	230V / 1P _H / 60Hz	A 224 24" T.I.
0-11116032/16	200-230V / 1P _H / 50-60Hz	A 224 24" T.I. MI 2V
0-11116041/16	400V / 3P _H / 50-60Hz	A 224 24" T.I. 2V
0-11116051/16	200-230V / 3P _H / 50-60Hz	A 224 24" T.I. 2V

WDK approved (certification # 04-022) only when equipped with SP2300 held device (see SP2300 Configurations # 1+2+5)

NEW



TRADITIONAL CAR TYRE CHANGERS

A 224 A

STANDARD ACCESSORIES

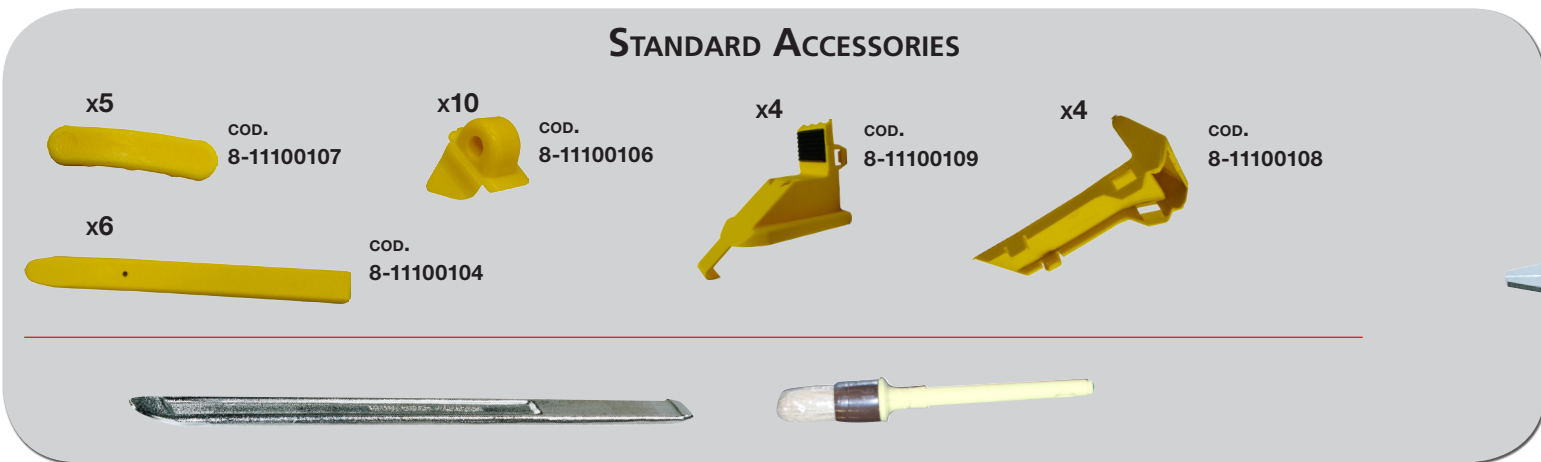

CODE	ELECTRICAL SUPPLY	DESCRIPTION
0-11115903/16	400V/3P _H /50Hz	A224 A 24"
0-11115904/16	230V/1P _H /50Hz	A224 A 24"
0-11115913/16	200-230V/3P _H /60Hz	A224 A 24"
0-11115914/16	230V/1P _H /60Hz	A224 A 24"
0-11115933/16	200-230V/1P _H /50 Hz	A224 A 24" 2V MI
0-11115943/16	400V/3P _H /50Hz	A224 A 24" 2V
0-11115952/16	200-230V/3P _H /60Hz	A224 A 24" 2V
0-11116003/16	400V/3P _H /50Hz	A224 A 24" T.I.
0-11116004/16	230V/1P _H /50Hz	A224 A 24" T.I.
0-11116013/16	200-230V/3P _H /60Hz	A224 A 24" T.I.
0-11116014/16	230V/1P _H /60Hz	A224 A 24" T.I.
0-11116034/16	200-230V/1P _H /50 Hz	A224 A 24" T.I. 2V MI
0-11116042/16	400V/3P _H /50Hz	A224 A 24" T.I. 2V
0-11116053/16	200-230V/3P _H /60Hz	A224 A 24" T.I. 2V

NEW



TRADITIONAL CAR TYRE CHANGERS

A 222

STANDARD ACCESSORIES



for NO TI versions only



CODE	ELECTRICAL SUPPLY	DESCRIPTION
0-11118001/16	400V/3P _H /50Hz	A222 22"
0-11118002/16	230V/1P _H /50Hz	A222 22"
0-11118011/16	200-230V/3P _H /60Hz	A222 22"
0-11118012/16	230V/1P _H /60Hz	A222 22"
0-11118032/16	200-230V/1P _H /50Hz	A222 22" 2V MI
0-11118041/16	400V/3P _H /50Hz	A222 22" 2V
0-11118051/16	200-230V/3P _H /60Hz	A222 22" 2V
0-11117901/16	400V/3P _H /50Hz	A222 22" TI
0-11117902/16	230V/1P _H /50Hz	A222 22" TI
0-11117911/16	200-230V/3P _H /60Hz	A222 22" TI
0-11117912/16	230V/1P _H /60Hz	A222 22" TI
0-11117932/16	200-230V/1P _H /50Hz	A222 22" TI 2V MI
0-11117934/16	115V/1P _H /60Hz	A222 22" TI 2V MI ASME
0-11117941/16	400V/3P _H /50Hz	A222 22" TI 2V
0-11117951/16	200-230V/3P _H /60Hz	A222 22" TI 2V

NEW



TRADITIONAL CAR TYRE CHANGERS

A 2020

STANDARD ACCESSORIES

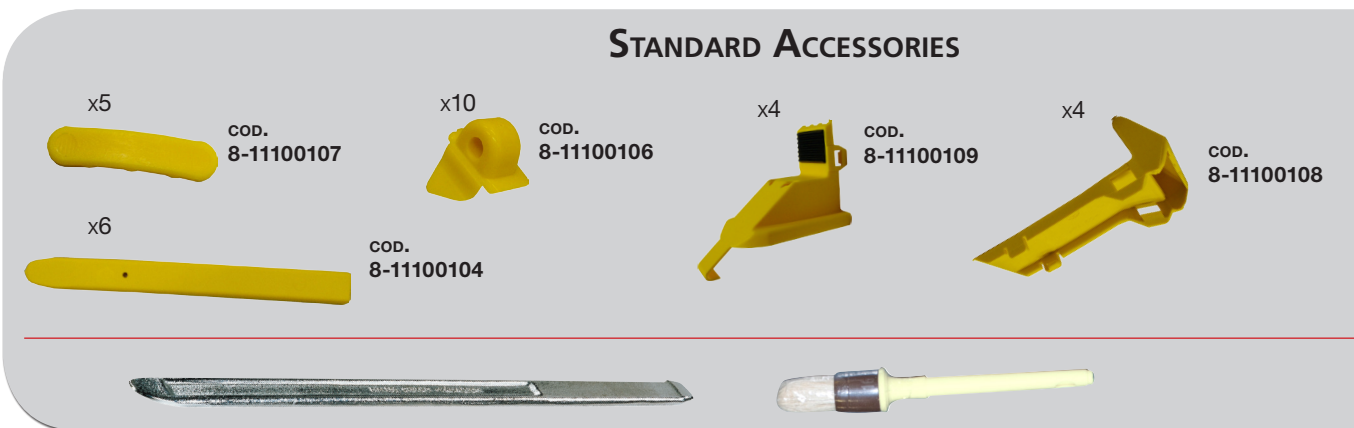

CODE	ELECTRICAL SUPPLY	DESCRIPTION
0-11100901/16	400V / 3P _H / 50Hz	A 2020 20"
0-11100902/16	200-230V / 1P _H / 50Hz	A 2020 20"
0-11100912/16	200-230V / 1P _H / 60Hz	A 2020 20"
0-11100921/16	200-230V / 3P _H / 50Hz	A 2020 20"
0-11101001/16	400V / 3P _H / 50Hz	A 2020 20" T.I.
0-11101051/16	200-230V / 3P _H / 60Hz	A 2020 20" T.I.
0-11101021/16	200-230V / 3P _H / 50Hz	A 2020 20" T.I.
0-11101002/16	200-230V / 1P _H / 50Hz	A 2020 20" T.I.
0-11101005/16	AIR MOTOR	A 2020 20" T.I. AIR MOTOR
0-11100952/16	200-230V / 1P _H / 50-60Hz	A 2020 20" MI 2V
0-11101052/16	200-230V / 1P _H / 50Hz	A 2020 20" T.I. MI 2V
0-11101044/16	110V / 1P _H / 60Hz	A 2020 20" T.I. MI 2V
0-11101012/16	200-230V / 3P _H / 50Hz	A 2020 20" T.I. MI 2V with SP3000 and WDK kit 04-006
0-11101022/16	200-230V / 1P _H / 50Hz	A 2020 20" T.I. MI 2V with SP2000 and WDK kit 04-003
0-11101023/16	200-230V / 1P _H / 50Hz	A 2020 20" T.I. MI 2V with SP2300 and WDK kit 04-018
0-11101071/16	400V / 3P _H / 50Hz	A 2020 20" T.I. without tank

NEW



TRADITIONAL CAR TYRE CHANGERS

A 2015

STANDARD ACCESSORIES

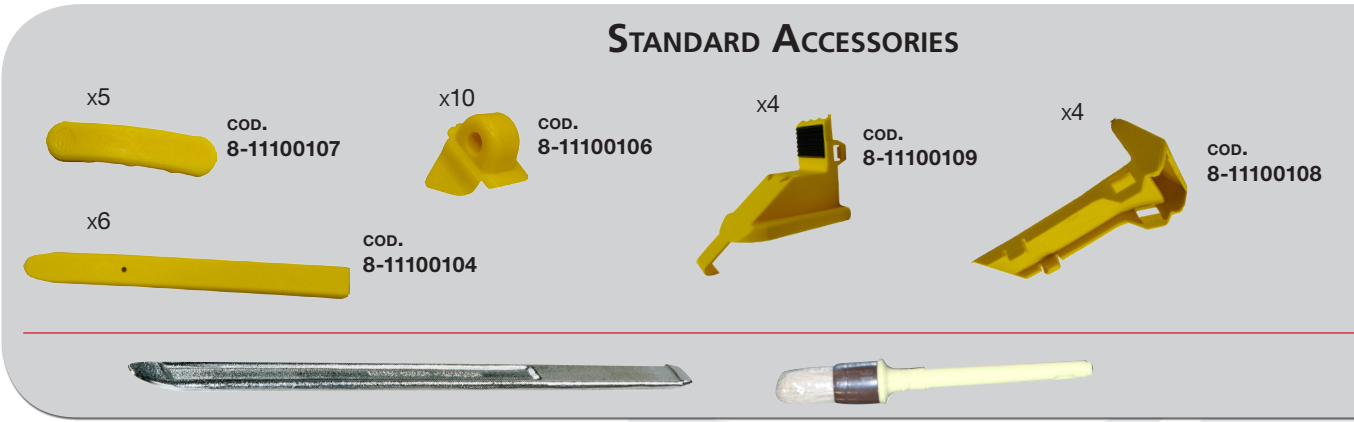

CODE	ELECTRICAL SUPPLY	DESCRIPTION
0-11100701/16	400V / 3PH / 50Hz	A 2015 20"
0-11100702/16	200-230V / 1PH / 50Hz	A 2015 20"
0-11100711/16	200-230V / 3PH / 60Hz	A 2015 20"
0-11100712/16	200-230V / 1PH / 60Hz	A 2015 20"
0-11100721/16	200-230V / 3PH / 50Hz	A 2015 20"
0-11100742/16	200-230V / 1PH / 50-60Hz	A 2015 20" MI 2V
0-11100842/16	200-230V / 1PH / 50-60Hz	A 2015 20" T.I. MI 2V
0-11100801/16	400V / 3PH / 50Hz	A 2015 20" T.I.
0-11100802/16	200-230V / 1PH / 50Hz	A 2015 20" T.I.
0-11100804/16	100-115V / 1PH / 60Hz	A 2015 20" T.I.
0-11100811/16	200-230V / 3PH / 60Hz	A 2015 20" T.I.
0-11100812/16	200-230V / 1PH / 60Hz	A 2015 20" T.I.
0-11100821/16	200-230V / 3PH / 50Hz	A 2015 20" T.I.
0-11100822/16	200-230V / 1PH / 50Hz	A 2015 20" T.I. 2V MI with SP2000 and WDK kit 04-003
0-11100852/16	200-230V / 1PH / 50Hz	A 2015 20" T.I. 2V MI with SP3000 and WDK kit 04-006
0-11100862/16	200-230V / 1PH / 50Hz	A 2015 20" T.I. 2V MI with SP2300 and WDK kit 04-019
0-11100871/16	400V / 3PH / 50Hz	A 2015 20" T.I. without tank

NEW



TRADITIONAL CAR TYRE CHANGERS

A 2005

STANDARD ACCESSORIES

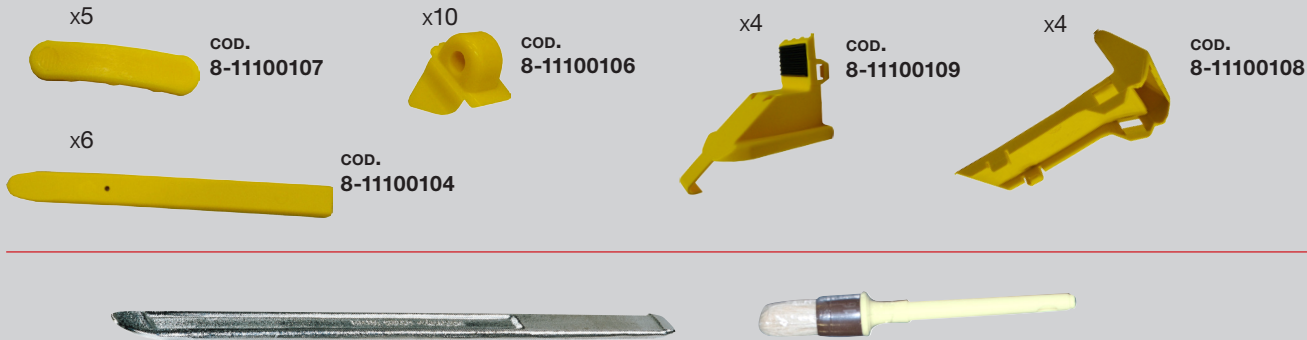

CODE	ELECTRICAL SUPPLY	DESCRIPTION
0-11100601/16	400V / 3PH / 50Hz	A 2005 20"
0-11100602/16	200-230V / 1PH / 50Hz	A 2005 20"
0-11100605/16	AIR MOTOR	A 2005 20"
0-11100621/16	200-230V / 3PH / 50Hz	A 2005 20"

NEW

CORGHI

TRADITIONAL CAR TYRE CHANGERS

A 2002

STANDARD ACCESSORIES



COD.
8-11600126







CODE	ELECTRICAL SUPPLY	DESCRIPTION
0-11117401/16	400V / 3PH / 50Hz	A 2002 22"
0-11117421/16	200-230V / 3PH / 50Hz	A 2002 22"
0-11117411/16	200-230V / 3PH / 60Hz	A 2002 22"
0-11117402/16	200-230V / 1PH / 50Hz	A 2002 22"
0-11117412/16	200-230V / 1PH / 60Hz	A 2002 22"
0-11117405/16	AIR MOTOR	A 2002 22" Air Motor
0-11117406/16	12 VOLT	A 2002 22" 12 Volt
0-11117501/16	400V / 3PH / 50Hz	A 2002 22" T.I.
0-11117521/16	200-230V / 3PH / 50Hz	A 2002 22" T.I.
0-11117502/16	200-230V / 1PH / 50Hz	A 2002 22" T.I.
0-11117512/16	200-230V / 1PH / 60Hz	A 2002 22" T.I.

NEW

CORCHI

ACCESSORIES FOR "TRADITIONAL" TYRE CHANGERS



ACCESSORIES FOR "TRADITIONAL" TYRE CHANGERS				A2030	A2025 LL	A2025	A224	A222	A2020	A2015	A2005	A2002
	DESCRIPTION	CODE										
COMPLEMENTARY EQUIPMENTS												
	MOBILE RIVER - Roller unit for wheel transfer	0-11109201/16		○	○	○	○	○	○	○	○	-
	MOBILE RIVER - Kit for Mobile River	8-11100240		○	○	○	○	○	○	○	○	-
	PSR Portable - PAX support remover	8-11100079		○	○	○	○	○	○	○	○	-
	PTR Roller bead presser	8-11100237		○	○	○	○	○	○	○	○	○
	P.S.T. Pneumatic shutter tyre	8-11100368		○	○	○	○	-	○	○	○	-

NEW

■ = Standard ○ = Compatible - = NOT compatible

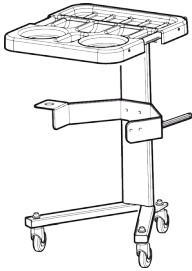

ACCESSORIES FOR "TRADITIONAL" TYRE CHANGERS







ACCESSORIES FOR "TRADITIONAL" TYRE CHANGERS				A2030	A2025 LL	A2025	A224	A222	A2020	A2015	A2005	A2002
	DESCRIPTION	CODE										
COMPLEMENTARY EQUIPMENTS												
	Easytrolley Tools and accessories holder trolley	0-51100101/16		○	○	○	○	○	○	○	○	○
	Easytrolley T.I. Tools and accessories holder trolley with tubeless system T.I.	0-51100102/16		○	○	○	○	○	○	○	○	○
	WL60 Wheel lifter	8-11600004		○	○	○	○	-	○	○	○	○

NEW

■ = Standard ○ = Compatible - = NOT compatible



ACCESSORIES FOR "TRADITIONAL" TYRE CHANGERS

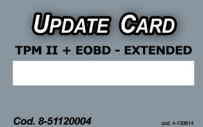

ACCESSORIES FOR "TRADITIONAL" TYRE CHANGERS				A2030	A2025 LL	A2025	A224	A222	A2020	A2015	A2005	A2002
	DESCRIPTION	CODE										
COMPLEMENTARY EQUIPMENTS												
	TPM 02 Device for checking operation of TPMS sensors	0-51100502		0	0	0	0	0	0	0	0	0
	EOBD Kit	8-51120002		0	0	0	0	0	0	0	0	0
	TPM02+Kit EOBD	0-51100701		0	0	0	0	0	0	0	0	0
	Subscription 12M TPM-02 standard	8-51100029										
	Subscription 12M TPM-02 extended	8-51120003										
	Subscription 12M TPM-02 + EOBD	8-51120001		0	0	0	0	0	0	0	0	0
	Subscription 12M TPM-02 + EOBD extended	8-51120004										

NEW

■ = Standard ○ = Compatible - = NOT compatible



ACCESSORIES FOR "TRADITIONAL" TYRE CHANGERS

ACCESSORIES FOR "TRADITIONAL" TYRE CHANGERS				A2030	A2025 LL	A2025	A224	A222	A2020	A2015	A2005	A2002
	DESCRIPTION	CODE										
COMPLEMENTARY EQUIPMENTS												
	Bluetooth printer	8-51100035		o	o	o	o	o	o	o	o	o
	Cable for printer (USB -> RS232)	8-51100036		o	o	o	o	o	o	o	o	o
	Barcode reader	8-51100037		o	o	o	o	o	o	o	o	o

NEW

■ = Standard o = Compatible - = NOT compatible

ACCESSORIES FOR "TRADITIONAL" TYRE CHANGERS

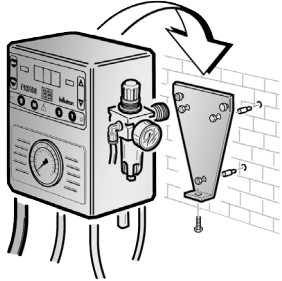



ACCESSORIES FOR "TRADITIONAL" TYRE CHANGERS				A2030	A2025 LL	A2025	A224	A222	A2020	A2015	A2005	A2002
	DESCRIPTION	CODE										
INFLATRON APPLICATIONS												
	Inflatron - Tyre inflator : installation on the tyre changer	8-11400047		○	○	○	○	-	○	○	○	-
	Inflatron - Tyre inflator: wall mounting	8-11400048		○	○	○	○	○	○	○	○	-

NEW

■ = Standard ○ = Compatible - = NOT compatible



ACCESSORIES FOR "TRADITIONAL" TYRE CHANGERS



ACCESSORIES FOR "TRADITIONAL" TYRE CHANGERS			A2030	A2025 LL	A2025	A224	A222	A2020	A2015	A2005	A2002
	DESCRIPTION	CODE									
SP 2300 APPLICATIONS											
	Complete kit SP2300 - disc version	8-11120042	○	○	○	○	-	○	○	○	-
	Complete kit SP2300 (disc version) only for A222	8-11120043	-	-	-	-	○	-	-	-	-
	Complete kit SP2300 with standard roller (suitable for all models, except A222, for A2030 starting from serial # CML146345)	8-11120045	○	○	○	○	-	○	○	○	-
	Complete kit SP2300 (with standard roller) only for A222	8-11120044	-	-	-	-	○	-	-	-	-
	Bead pressing cone kit	8-11100311	-	○	○	○	○	○	○	-	-
	Extension for bead pressing cone	8-11100153	-	○	○	○	○	○	○	-	-

NEW

■ = Standard ○ = Compatible - = NOT compatible



ACCESSORIES FOR "TRADITIONAL" TYRE CHANGERS



ACCESSORIES FOR "TRADITIONAL" TYRE CHANGERS				A2030	A2025 LL	A2025	A224	A222	A2020	A2015	A2005	A2002
	DESCRIPTION	CODE										
BPL SX HELP DEVICE												
	BPL Bead pressing left.	8-11120032		-	-	-	-	0	-	-	-	0
SP 300 APPLICATIONS												
	Universal multifunctional device SP300	8-11100343		0	0	0	0	0	0	0	0	-
	Installation and customisation kit	8-11100344		0	0	0	0	-	0	0	0	-
	Installation and customisation kit for A 222	8-11120039		-	-	-	-	0	-	-	-	-
	SP 3000 Help device	8-11100123		0	0	0	0	-	0	0	0	-

NEW

■ = Standard ○ = Compatible - = NOT compatible

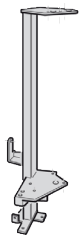

ACCESSORIES FOR "TRADITIONAL" TYRE CHANGERS

ACCESSORIES FOR "TRADITIONAL" TYRE CHANGERS				A2030	A2025 LL	A2025	A224	A222	A2020	A2015	A2005	A2002
	DESCRIPTION	CODE										
SP 3000 APPLICATIONS												
	Adapter kit for SP3000	8-11100122		○	○	○	○	-	○	○	○	-
SP 2000 APPLICATIONS												
	SP 2000 Help device with disc lifter (including adapting kit)	8-11120047		○	○	○	○	-	○	○	○	-
	Rim pressing tool (to use with SP 2000)	801255584		○	○	○	○	-	○	○	○	-

NEW

■ = Standard ○ = Compatible - = NOT compatible



ACCESSORIES FOR "TRADITIONAL" TYRE CHANGERS

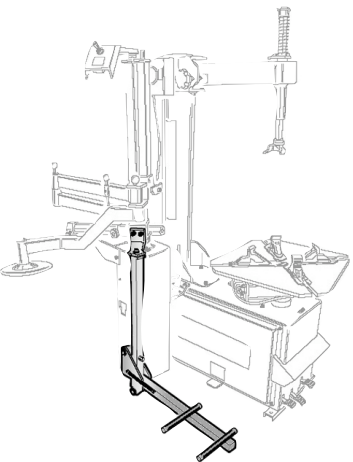

ACCESSORIES FOR "TRADITIONAL" TYRE CHANGERS				A2030	A2025 LL	A2025	A224	A222	A2020	A2015	A2005	A2002
	DESCRIPTION	CODE										
PU 1500 APPLICATIONS												
	PU 1500 Including adapter kit, rim pressing device and bead lifting device	8-11120046		○	○	○	○	-	○	○	○	○
	Wheel lifting arm	8-11100072		○	○	○	○	-	○	○	○	-

NEW

■ = Standard ○ = Compatible - = NOT compatible

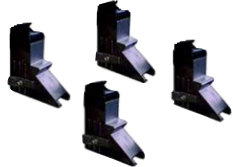
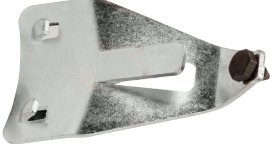

ACCESSORIES FOR "TRADITIONAL" TYRE CHANGERS





ACCESSORIES FOR "TRADITIONAL" TYRE CHANGERS				A2030	A2025 LL	A2025	A224	A222	A2020	A2015	A2005	A2002
	DESCRIPTION	CODE										
CLAMPING AND MOTORCYCLE ADAPTERS												
	Set of 4 adapters for 15"- 23" for motorcycle rims	801258650		○	○	○	○	○	○	○	○	-
	Motorcycle breaker blade	801260402		-	-	-	-	○	○	○	○	○
	Set of 4 adapters for 8"- 24" rims	801263517		○	○	○	○	○	○	○	○	-
SPECIAL TOOLS												
	Pneumatic bead pressing tool with support (for equipment produced after 10/2004)	8-11100100		○	○	○	○	-	○	○	○	-

NEW

■ = Standard ○ = Compatible - = NOT compatible



ACCESSORIES FOR "TRADITIONAL" TYRE CHANGERS







ACCESSORIES FOR "TRADITIONAL" TYRE CHANGERS				A2030	A2025 LL	A2025	A224	A222	A2020	A2015	A2005	A2002
	DESCRIPTION	CODE										
SPECIAL TOOLS												
	Sliding bead pressing clamp	8-11100120		-	o	o	o	o	o	o	o	-
	Plastic head tool complete with support	801250309		-	-	o	o	-	o	o	o	-
	Scooter m/d head tool for 8" rims	801252083		-	-	o	o	-	o	o	o	-
	RS Head tool, special for Ford - VW - Fiat	8-11100008		-	-	o	o	-	o	o	o	-
	M/D head tool fast fitting kit	8-11100001		-	-	o	o	-	o	o	o	-

NEW

■ = Standard o = Compatible - = NOT compatible







ACCESSORIES FOR "TRADITIONAL" TYRE CHANGERS

ACCESSORIES FOR "TRADITIONAL" TYRE CHANGERS				A2030	A2025 LL	A2025	A224	A222	A2020	A2015	A2005	A2002
	DESCRIPTION	CODE										
SPECIAL TOOLS												
	Plastic bead pressing lever with cord	801261910		○	○	○	○	○	○	○	○	-
	Bead pressing clamp for run flat tyres	801262417		○	○	○	○	○	○	○	○	-
	Plastic bead pressing clamp	801435685		○	○	○	○	○	○	○	○	-
	Valve-inserting lever	801461004		○	○	○	○	○	○	○	○	-
	Valve score screwdriver	801461005		○	○	○	○	○	○	○	○	-
	5 kg grease bucket holder	801232202		○	○	○	○	○	○	○	○	-

NEW

■ = Standard ○ = Compatible - = NOT compatible

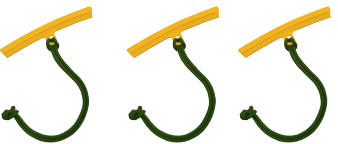
ACCESSORIES FOR "TRADITIONAL" TYRE CHANGERS







ACCESSORIES FOR "TRADITIONAL" TYRE CHANGERS			A2030	A2025 LL	A2025	A224	A222	A2020	A2015	A2005	A2002
	DESCRIPTION	CODE									
PLASTIC PROTECTIONS FOR ALLOY RIMS											
IMAGE NOT AVAILABLE	Set of 12 black plastic inside clamp protections.	8-11100044	-	-	-	-	-	-	-	-	0
IMAGE NOT AVAILABLE	Set of 6 black plastic protections for breaker blade.	801258383	-	-	-	-	-	-	-	-	0
IMAGE NOT AVAILABLE	Set of 6 black plastic protections for bead lever	801246241	-	-	-	-	-	-	-	-	0
	Set of 4 adapters for 8-9" rims (it can lock from outside rims up to 6").	8-11100042	-	-	-	-	-	-	-	-	0
	Set of 4 adapters for increasing outside locking of 4".	8-11100041	-	-	-	-	-	-	-	-	0
	Set of 4 motorcycle adaptors.	8-11100036	-	-	-	-	-	-	-	-	0
	REP - 3 rim edge plastic protections (yellow)	8-11120014	0	0	0	0	0	0	0	0	-
	REPS - 3 rim edge shortplastic protections (yellow)	8-11120015	0	0	0	0	0	0	0	0	-

NEW

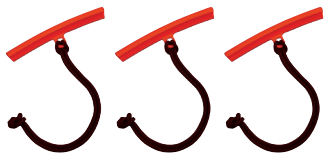
■ = Standard ○ = Compatible - = NOT compatible







ACCESSORIES FOR "TRADITIONAL" TYRE CHANGERS

ACCESSORIES FOR "TRADITIONAL" TYRE CHANGERS				A2030	A2025 LL	A2025	A224	A222	A2020	A2015	A2005	A2002
	DESCRIPTION	CODE										
PLASTIC PROTECTIONS FOR ALLOY RIMS												
	3 plastic protections for rim edge	801461007		○	○	○	○	○	○	○	○	-
x6 	6 plastic protections for bead lever	8-11100104		○	○	○	○	○	○	○	○	-
x6 	6 plastic protections for breaker blade	8-11100105		○	○	○	○	○	○	○	○	-
x10 	10 front plastic inserts for head tool	8-11100106		■	-	■	■	■	■	■	■	-
x5 	5 bottom plastic inserts for head tool	8-11100107		■	-	■	■	■	■	■	■	-
x12 	12 front plastic inside clamp protections	8-11100108		■	■	■	■	○	■	■	■	-
x12 	12 front plastic outside clamp protections	8-11100109		■	■	■	■	○	■	■	■	-

NEW

■ = Standard ○ = Compatible - = NOT compatible

ACCESSORIES FOR "TRADITIONAL" TYRE CHANGERS

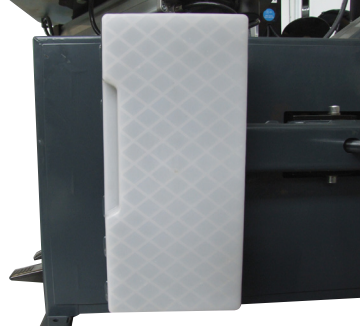
ACCESSORIES FOR "TRADITIONAL" TYRE CHANGERS				A2030	A2025 LL	A2025	A224	A222	A2020	A2015	A2005	A2002
	DESCRIPTION	CODE										
PLASTIC PROTECTIONS FOR ALLOY RIMS												
x10 	10 front plastic inserts for RS head tool	8-11100045		0	-	0	0	-	0	0	0	-
x5  x10	Spare kit of leverless tool head plastic protections	8-11400293		-	0	-	-	-	-	-	-	-
x10 	10 plastic pax system protections "reglettes"	801260235		0	0	0	0	-	0	0	0	-
	6 plastic protections for sliding bead pressing clamp (for cod. 8-11100120)	8-11100126		0	0	0	0	-	0	0	0	-
	Plastic protection for bead breaker pad (1 pcs)	801458663		0	0	0	0	0	0	0	0	-

NEW

■ = Standard ○ = Compatible - = NOT compatible

MOTORCYCLE TYRE CHANGERS

BC200 S

STANDARD ACCESSORIES

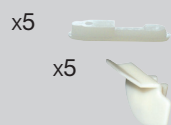

x5

x5

MPK3
COD.
8-11400096

x6



PPM
COD.
8-11600020

x2



KPPL
COD.
8-11400073

x4

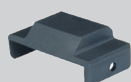

GK
COD.
8-11600123

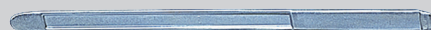

ULM
COD.
3019000









CODE	ELECTRICAL SUPPLY	DESCRIPTION
0-11607205/16	400V / 3PH / 50Hz	BC200 S
0-11607305/16	230V / 3PH / 50Hz	BC200 S
0-11607201/16	230V / 1 PH / 50Hz	BC200 S
0-11607206/16	230V / 1 PH / 60Hz	BC200 S

NEW









ACCESSORIES FOR BC200 S

	DESCRIPTION	CODE	
x6 	PPM kit of 6 protections for shoe	8-11600020	
	SR wheel support kit	8-11600116	
	PR wheel mounting roller kit	8-11600117	
x4 	UCA - Set 4 motocross clamps	8-11600118	
x4 	ATV A - atv adaptors kit	8-11600119	
	ATV C - atv centring kit	8-11600120	

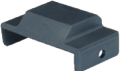
NEW

ACCESSORIES FOR BC200 S

	DESCRIPTION	CODE	
	CKM - locking clamps kit (4 pcs)	8-11600121	
x4 	GKS - plastic protections kit	8-11600122	
x4 	GK - go-kart adaptors kit (4 pcs)	8-11600123	
	Tools holder	8-11600124	
	Grease bucket 1 kg	8-11600125	
	CE inflating pistol	8-11600126	

NEW

SUPER AUTOMATIC HEAVY-DUTY TYRE CHANGERS WITH "LEVA LA LEVA" TECHNOLOGY

MONSTER AG TT

58"



STANDARD ACCESSORIES



COD.
219244



COD.
426388



COD.
2105954

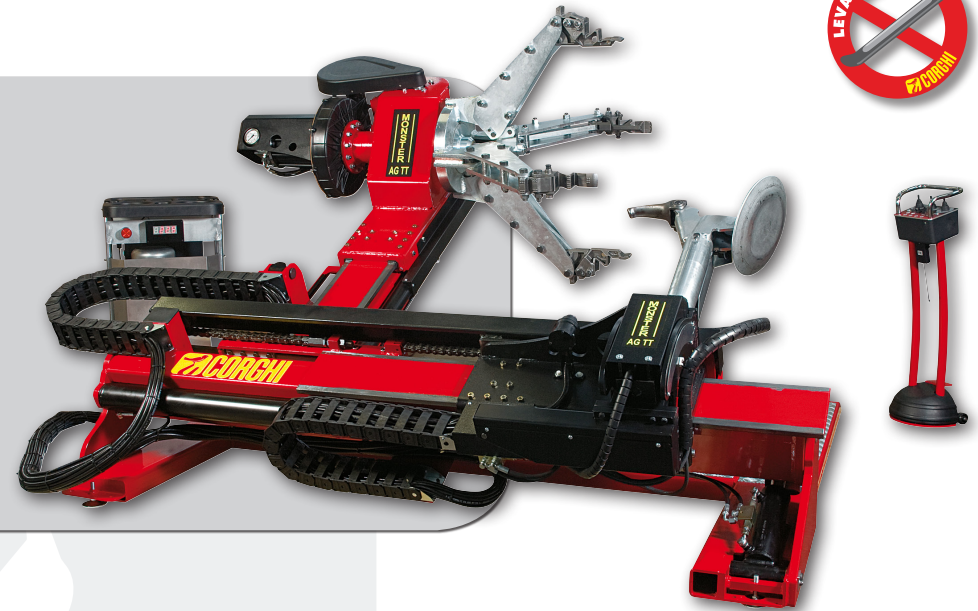

CODE	ELECTRICAL SUPPLY	DESCRIPTION
0-12101501/16	400V / 3PH / 50Hz	MONSTER AG TT
0-12101503/16	400V / 3PH / 60Hz	MONSTER AG TT
0-12101502/16	200-208-230V / 3PH / 50Hz	MONSTER AG TT
0-12101504/16	200-208-230V / 3PH / 60Hz	MONSTER AG TT

NEW

CORGI

AUTOMATIC HEAVY-DUTY TYRE CHANGERS

AG TT 1600 A

58"

STANDARD ACCESSORIES



COD.
219244



COD.
426388



COD.
2105954



CODE	ELECTRICAL SUPPLY	DESCRIPTION
0-12101701/16	400V / 3PH / 50Hz	AG TT 1600 A
0-12101703/16	400V / 3PH / 60Hz	AG TT 1600 A
0-12101702/16	200-208-230V / 3PH / 50Hz	AG TT 1600 A
0-12101704/16	200-208-230V / 3PH / 60Hz	AG TT 1600 A

NEW



AUTOMATIC HEAVY-DUTY TYRE CHANGERS

HD 1800 HYDRUS

60''

STANDARD ACCESSORIES



COD.
219244



COD.
426388



COD.
2105954



CODE	ELECTRICAL SUPPLY	DESCRIPTION
0-12104001/16	400V / 3P _H / 50Hz	HD 1800 HYDRUS
0-12104002/16	230V / 3P _H / 60Hz	HD 1800 HYDRUS
0-12104003/16	400V / 3P _H / 60Hz	HD 1800 HYDRUS

NEW



AUTOMATIC HEAVY-DUTY TYRE CHANGERS

HD 1400 EVO

Evolution

58"

STANDARD ACCESSORIES



COD.
219244



COD.
426388



COD.
2105954



CODE	ELECTRICAL SUPPLY	DESCRIPTION
0-12100306/16	400V/3Ph/50Hz	HD1400 EVO Hydraulic
0-12100307/16	230V/3Ph/50Hz	HD1400 EVO Hydraulic
0-12100308/16	400V/3Ph/60Hz	HD1400 EVO Hydraulic
0-12100309/16	230V/3Ph/60Hz	HD1400 EVO Hydraulic

NEW



AUTOMATIC HEAVY-DUTY TYRE CHANGERS

HD 1300 A

56''

STANDARD ACCESSORIES



COD.
219244



COD.
426388



COD.
2105954



CODE	ELECTRICAL SUPPLY	DESCRIPTION
0-12103601/16	400V/3Ph/50Hz	HD 1300 A
0-12103603/16	400V/3Ph/60Hz	HD 1300 A
0-12103602/16	230V/3Ph/50Hz	HD 1300 A
0-12103604/16	230V/3Ph/60Hz	HD 1300 A

NEW



AUTOMATIC HEAVY-DUTY TYRE CHANGERS

HD 1300 A R RADIO

56''

STANDARD ACCESSORIES



COD.
219244



COD.
426388



COD.
2105954



CODE	ELECTRICAL SUPPLY	DESCRIPTION
0-12103801/16	400V/3Ph/50Hz	HD 1300 A R
0-12103803/16	400V/3Ph/60Hz	HD 1300 A R
0-12103802/16	230V/3Ph/50Hz	HD 1300 A R
0-12103804/16	230V/3Ph/60Hz	HD 1300 A R

NEW



AUTOMATIC HEAVY-DUTY TYRE CHANGERS

HD 800 A

STANDARD ACCESSORIES



COD.
219244



COD.
426388



COD.
2105954



26"

CODE	ELECTRICAL SUPPLY	DESCRIPTION
0-12103101/16	400V / 3P _H / 50Hz	HD 800 A
0-12103103/16	400V / 3P _H / 60Hz	HD 800 A
0-12103102/16	230V / 3P _H / 50Hz	HD 800 A
0-12103104/16	230V / 3P _H / 60Hz	HD 800 A

NEW

 **CORGHI**

SEMI-AUTOMATIC HEAVY-DUTY TYRE CHANGERS

HD 1400 E Evo

Evolution

58"

STANDARD ACCESSORIES



COD.
219244



COD.
426388



COD.
2105954



CODE	ELECTRICAL SUPPLY	DESCRIPTION
0-12100406/16	400V / 3PH / 50Hz	HD 1400 E EVO Electrohydraulic
0-12100407/16	230V / 3PH / 50Hz	HD 1400 E EVO Electrohydraulic
0-12100408/16	400V / 3PH / 60Hz	HD 1400 E EVO Electrohydraulic
0-12100409/16	230V / 3PH / 60Hz	HD 1400 E EVO Electrohydraulic

NEW

CORGI

SEMI-AUTOMATIC HEAVY-DUTY TYRE CHANGERS

HD 1300 BASE

56"

STANDARD ACCESSORIES



COD.
219244



COD.
426388



COD.
2105954



CODE	ELECTRICAL SUPPLY	DESCRIPTION
0-12103501/16	400V/3Ph/50Hz	HD 1300
0-12103503/16	400V/3Ph/60Hz	HD 1300
0-12103502/16	230V/3Ph/50Hz	HD 1300
0-12103504/16	230V/3Ph/60Hz	HD 1300

NEW

CORGI

SEMI-AUTOMATIC HEAVY-DUTY TYRE CHANGERS

HD 1300 R RADIO

56''

STANDARD ACCESSORIES



COD.
219244



COD.
426388



COD.
2105954



CODE	ELECTRICAL SUPPLY	DESCRIPTION
0-12103701/16	400V/3Ph/50Hz	HD 1300 R
0-12103703/16	400V/3Ph/60Hz	HD 1300 R
0-12103702/16	230V/3Ph/50Hz	HD 1300 R
0-12103704/16	230V/3Ph/60Hz	HD 1300 R

NEW

CORGHI

SEMI-AUTOMATIC HEAVY-DUTY TYRE CHANGERS

HD 900

56"

STANDARD ACCESSORIES



COD.
219244



COD.
426388



COD.
2105954



CODE	ELECTRICAL SUPPLY	DESCRIPTION
0-12102301/16	400V / 3P _H / 50Hz	HD 900 Electrohydraulic
0-12102302/16	230V / 3P _H / 50Hz	HD 900 Electrohydraulic
0-12102303/16	400V / 3P _H / 60Hz	HD 900 Electrohydraulic
0-12102304/16	230V / 3P _H / 60Hz	HD 900 Electrohydraulic

NEW



SEMI-AUTOMATIC HEAVY-DUTY TYRE CHANGERS

HD 700

26"

STANDARD ACCESSORIES



COD.
219244



COD.
426388



COD.
2105954



CODE	ELECTRICAL SUPPLY	DESCRIPTION
0-12101801/16	400V / 3P _H / 50Hz	HD 700 Electrohydraulic
0-12101802/16	230V / 3P _H / 50Hz	HD 700 Electrohydraulic
0-12101803/16	400V / 3P _H / 60Hz	HD 700 Electrohydraulic
0-12101804/16	230V / 3P _H / 60Hz	HD 700 Electrohydraulic

NEW

 CORCHI

SEMI-AUTOMATIC HEAVY-DUTY TYRE CHANGERS

HD 500

26"

STANDARD ACCESSORIES



COD.
219244



COD.
801289440



COD.
2016581



COD.
2105954

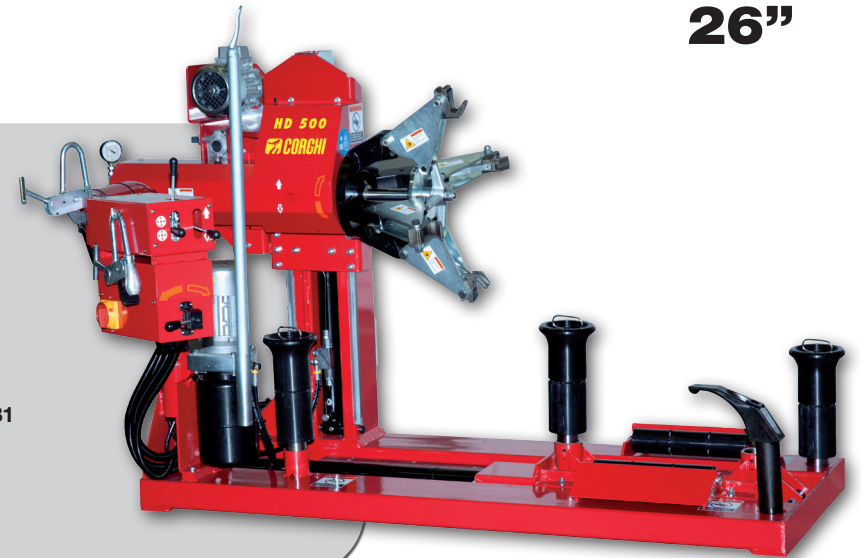

CODE	ELECTRICAL SUPPLY	DESCRIPTION
0-12100801/16	400V / 3PH / 50Hz	HD 500
0-12100802/16	230V / 3PH / 60Hz	HD 500
0-12100803/16	230V / 1PH / 60Hz	HD 500
0-12100804/16	230V / 1PH / 50Hz	HD 500

NEW

CORGHI

HEAVY-DUTY TYRE CHANGER FOR MOBILE SERVICE

AGT TILT

STANDARD ACCESSORIES



COD.
219244



COD.
426388



COD.
36022258B



COD.
2105954



CODE	ELECTRICAL SUPPLY	DESCRIPTION
	400V/3Ph/50Hz	AGT TILT Truck mobile workshop complete with tyre changer + generator
0-12104101/16	400V/3Ph/50Hz	AGT TILT Truck mobile workshop complete with tyre changer without generator

NEW



HEAVY-DUTY TYRE CHANGER FOR MOBILE SERVICE

HD 650 TILT

STANDARD ACCESSORIES



26"

CODE	ELECTRICAL SUPPLY	DESCRIPTION	
0-12101901/16	380-400V / 3PH / 50Hz	HD 650 TILT , Workstation complete with tyre changer with generator	
0-12102201/16	380-400V / 3PH / 50Hz	HD 650 TILT , Workstation with tyre changer without generator	
8-12100139		Customisation kit	

NEW





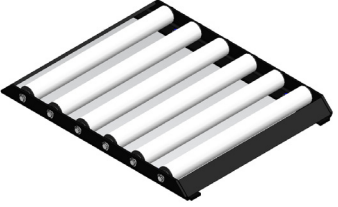
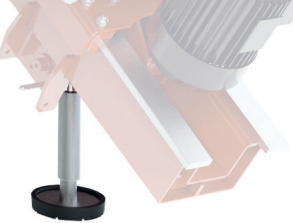

ACCESSORIES FOR HEAVY-DUTY TYRE CHANGER

ACCESSORIES FOR HEAVY-DUTY TYRE CHANGER			MONSTER AG TT	AG TT 1600 A	HD 1800 HYDRUS	HD 1400 EVO	HD 1300 A	HD 1300 A R	HD 800 A	HD 1400 E EVO	HD 1300 BASE	HD 1300 RADIO	HD 900	HD 700	HD 500	AGT TILT	HD 650 TILT	
	DESCRIPTION	CODE																
	CAR MATE for AGT Tilt	8-12120008/90		-	-	-	-	-	-	-	-	-	-	-	-	-	O	-
	Roller conveyor for AGT Tilt	8-12120011/90		-	-	-	-	-	-	-	-	-	-	-	-	-	O	-
	Extension for loading threshold 750 mm - AGT Tilt	8-12120009		-	-	-	-	-	-	-	-	-	-	-	-	-	O	-
	Extension for loading threshold 1000 mm - AGT Tilt	8-12120010		-	-	-	-	-	-	-	-	-	-	-	-	-	O	-

NEW

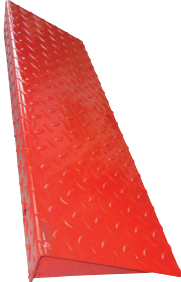
■ = Standard ○ = Compatible - = NOT compatible

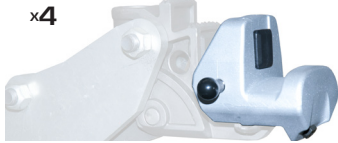



ACCESSORIES FOR HEAVY-DUTY TYRE CHANGER

	DESCRIPTION	CODE	MONSTER AG TT	AG TT 1600 A	HD 1800 HYDRUS	HD 1400 EVO	HD 1300 A	HD 1300 A R	HD 800 A	HD 1400 E EVO	HD 1300 BASE	HD 1300 RADIO	HD 900	HD 700	HD 500	AGT TILT	HD 650 TILT
	Horizontal charriot platform	8-12100039/16	-	-	-	-	-	-	-	-	-	-	-	-	○	-	-
	Side chassis platform	8-12100040/16	-	-	-	-	-	-	-	-	-	-	-	-	○	-	-
	DV 120 Bead pressing device	0-12100701	○	○	○	○	○	○	-	○	○	○	○	○	-	-	-
x4 	Protection kit for alloy rims	8-12100175	-	-	○	○	○	○	-	○	○	○	-	-	-	-	-
	Longer rim clamp for big tyre mounting	801224201	○	○	○	○	○	○	-	○	○	○	○	○	-	-	-

NEW

■ = Standard ○ = Compatible - = NOT compatible





ACCESSORIES FOR HEAVY-DUTY TYRE CHANGER

	DESCRIPTION	CODE	MONSTER AG TT	AG TT 1600 A	HD 1800 HYDRUS	HD 1400 EVO	HD 1300 A	HD 1300 A R	HD 800 A	HD 1400 E EVO	HD 1300 BASE	HD 1300 RADIO	HD 900	HD 700	HD 500	AGT TILT	HD 650 TILT
	Alloy rim clamp tool	801227195	○	○	○	○	○	○	○	○	○	○	○	○	○	-	○
	Locking pin for alloy rims	801237171	○	○	○	○	○	○	○	○	○	○	○	○	○	○	○
	Set of 4 aluminium protections for alloy rims	801254494	-	-	-	-	-	-	○	-	-	-	-	-	○	○	-
	Clamping for demounting	801217635	○	○	○	○	○	○	○	○	○	○	○	-	-	-	-
	Skidder clamp	801251904	○	○	○	○	○	○	-	○	○	○	○	-	-	-	-

NEW

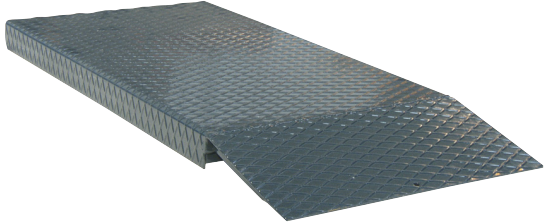
■ = Standard ○ = Compatible - = NOT compatible

ACCESSORIES FOR HEAVY-DUTY TYRE CHANGER



	DESCRIPTION	CODE	MONSTER AG TT	AG TT 1600 A	HD 1800 HYDRUS	HD 1400 EVO	HD 1300 A	HD 1300 A R	HD 800 A	HD 1400 EVO	HD 1300 BASE	HD 1300 RADIO	HD 900	HD 700	HD 500	AGT TILT	HD 650 TILT
	High runway platform	8-12100023	-	-	-	O	-	-	-	O	-	-	-	-	-	-	-
	Valve core screwdriver	801461005	O	O	O	O	O	O	O	O	O	O	O	O	O	O	O
	Radio remote control kit	8-12120005	-	-	-	O	-	-	-	O	-	-	-	-	-	-	-
	Kit radio - 120V input	8-12120006	-	-	-	O	-	-	-	O	-	-	-	-	-	-	-
	Radio remote control kit	8-12100036	■	O	-	-	-	-	-	-	-	-	-	-	-	-	-
	Bead breaker disc	8-12100030	-	-	-	-	-	-	-	-	-	-	-	-	-	O	O

NEW

■ = Standard O = Compatible - = NOT compatible

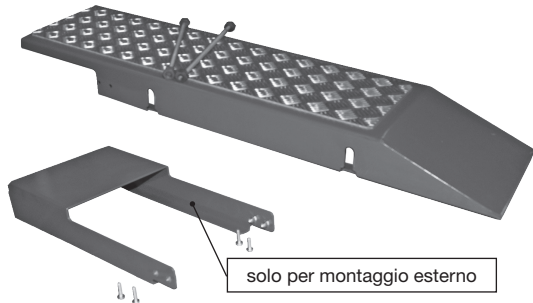

ACCESSORIES FOR HEAVY-DUTY TYRE CHANGER





ACCESSORIES FOR HEAVY-DUTY TYRE CHANGER			MONSTER AG TT	AG TT 1600 A	HD 1800 HYDRUS	HD 1400 EVO	HD 1300 A	HD 1300 A R	HD 800 A	HD 1400 E EVO	HD 1300 BASE	HD 1300 RADIO	HD 900	HD 700	HD 500	AGT TILT	HD 650 TILT
	DESCRIPTION	CODE															
IMMAGINE NON DISPONIBILE	Consumable plastic kit for 58"	8-12100038	○	○	-	-	-	-	-	-	-	-	-	-	-	-	-
	Platform kit	8-12100154/16	○	○	-	-	-	-	-	-	-	-	-	-	-	-	-
	Locking adapter for alloy wheels Ø 161 mm	8-12100007	○	○	○	○	○	○	○	○	○	○	○	○	○	○	○
	Locking adapter for alloy wheels Ø 164 mm	8-12100005	○	○	○	○	○	○	○	○	○	○	○	○	○	○	○
	Locking adapter for alloy wheels Ø 176 mm	8-12100006	○	○	○	○	○	○	○	○	○	○	○	○	○	○	○
	Locking adapter for alloy wheels Ø 202 mm	8-12100008	○	○	○	○	○	○	○	○	○	○	○	○	○	○	○
	Locking adapter for alloy wheels Ø 220 mm	8-12300001	○	○	○	○	○	○	○	○	○	○	○	○	○	○	○
	Locking adapter for alloy wheels Ø 221 mm	8-12100009	○	○	○	○	○	○	○	○	○	○	○	○	○	○	○
	Locking adapter for alloy wheels Ø 281 mm	8-12100010	○	○	○	○	○	○	○	○	○	○	○	○	○	○	○

NEW

■ = Standard ○ = Compatible - = NOT compatible



ACCESSORIES FOR HEAVY-DUTY TYRE CHANGER





ACCESSORIES FOR HEAVY-DUTY TYRE CHANGER			MONSTER AG TT	AG TT 1600 A	HD 1800 HYDRUS	HD 1400 EVO	HD 1300 A	HD 1300 A R	HD 800 A	HD 1400 E EVO	HD 1300 BASE	HD 1300 RADIO	HD 900	HD 700	HD 500	AGT TILT	HD 650 TILT
	DESCRIPTION	CODE															
	RT tubeless tyre roller for truck and bus wheels	2306040	-	-	-	○	○	○	-	○	○	○	○	○	-	-	-
	Tubeless tyre roller	19120018	-	-	-	-	-	-	○	-	-	-	-	-	-	-	-
	BBD Bead breaking disk	801289441	-	-	-	-	-	-	-	-	-	-	-	-	○	-	-
	SPI Special spare plastic inserts for GL clamps 4+4+4	8-11400200	-	-	-	○	○	○	-	○	○	○	○	○	○	-	-
	PA Set of 4 self-centring extensions - 4v	8-12100155	-	-	-	-	-	-	-	-	-	-	○	-	-	-	-

NEW

■ = Standard ○ = Compatible - = NOT compatible



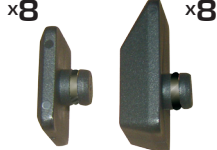

ACCESSORIES FOR HEAVY-DUTY TYRE CHANGER

ACCESSORIES FOR HEAVY-DUTY TYRE CHANGER			MONSTER AG TT	AG TT 1600 A	HD 1800 HYDRUS	HD 1400 EVO	HD 1300 A	HD 1300 A R	HD 800 A	HD 1400 E EVO	HD 1300 BASE	HD 1300 RADIO	HD 900	HD 700	HD 500	AGT TILT	HD 650 TILT
	DESCRIPTION	CODE															
	PA26 Set of 4 self-centring extensions- 4v : to increase self-centering chuck capacity up to 28”	8-12100176	-	-	-	-	-	-	○	-	-	-	-	-	○	○	-
	GL Set of 4 clamps for alloy rims	8-12100156	-	-	-	-	-	-	-	-	-	-	○	○	-	-	-
	P4P Four points extensions for rims with circlet	8-12100171	-	-	○	○	○	○	-	○	○	○	-	-	-	-	-
	SPIG Set of 8+8 clamp inserts	8-12100172	-	-	-	-	-	-	-	-	-	-	○	○	-	-	-
	Series 4 clamps and connecting rods	8-12100157	-	-	-	-	-	-	-	-	-	-	-	○	-	-	-

NEW

■ = Standard ○ = Compatible - = NOT compatible

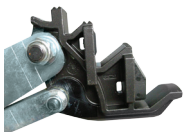
ACCESSORIES FOR HEAVY-DUTY TYRE CHANGER

ACCESSORIES FOR HEAVY-DUTY TYRE CHANGER				MONSTER AG TT	AG TT 1600 A	HD 1800 HYDRUS	HD 1400 EVO	HD 1300 A	HD 1300 A R	HD 800 A	HD 1400 E EVO	HD 1300 BASE	HD 1300 RADIO	HD 900	HD 700	HD 500	AGT TILT	HD 650 TILT
	DESCRIPTION	CODE																
x4 	Series 4 monobloc clamps	8-12100160		-	-	-	-	-	-	-	-	-	-	○	-	-	-	-
x4 	Kit clamps hole D. 80 mm	8-12100037		-	-	-	○	○	○	-	○	○	○	-	-	-	-	-

NEW

■ = Standard ○ = Compatible - = NOT compatible



NEXION S.p.A.

Strada Statale 468 n° 9 - 42015 CORREGGIO - R.E. - ITALY

Tel. ++39 0522 639.111 - Fax ++39 0522 639.150 - www.corgi.com - info@corgi.com



To protect the planet and reduce paper usage, our catalogues are viewable online at the website www.corgi.com. Printing responsibly contributes to saving the environment.

The manufacturer reserves the right to modify the features of its products at any time.
Code DPCG0005368_TC_EX_06-2018